

THE SERIAL DATA SUPERPOWER



- Exceptional Signal Characterization Performance
- Unrivalled Validation and Debug Capabilities
- Built-in Serial Data Expertise

WaveMaster 8000HD

20 GHz – 65 GHz

12-bit High Definition Oscilloscopes

Exceptional Signal Characterization Performance



The most powerful signal acquisition and processing platform available

- Up to 65 GHz bandwidth at 320 GS/s
- 12-bit resolution at full bandwidth and sample rate
- Fast processing of long waveforms

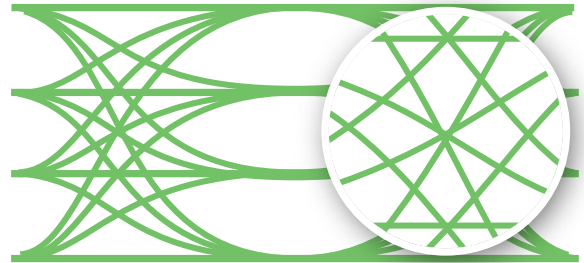

Unrivaed Validation and Debug Capabilities



Unmatched visibility into system-wide behaviors

- CrossSync™ PHY protocol analyzer synchronization
- The industry's longest acquisition memory
- Serial triggers, built-in digital inputs and high-impedance (1 M Ω) probe support

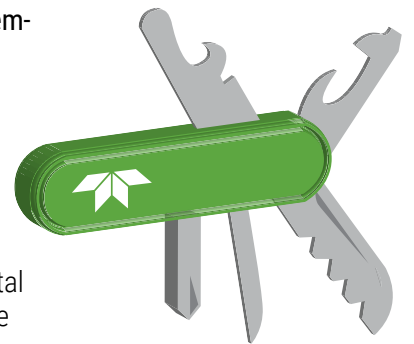

Built-in Serial Data Expertise

Simple and powerful analysis tools for serial data

- Tailored signal analysis for PCI Express®, USB-C®, DDR, and other technologies
- Powerful PAM and NRZ eye diagram, jitter and link analysis tools
- Simple automation of complex compliance testing

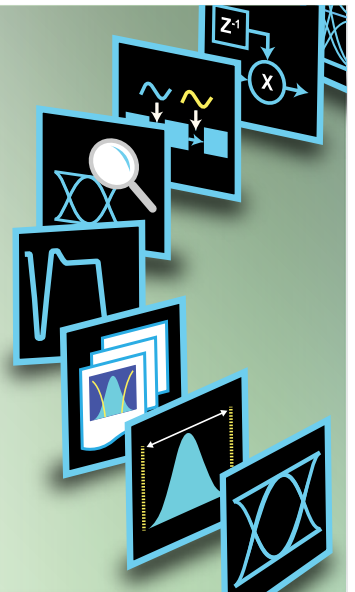



The Serial Data Superpower



WaveMaster 8000HD

TOTAL DEVELOPMENT CYCLE COVERAGE

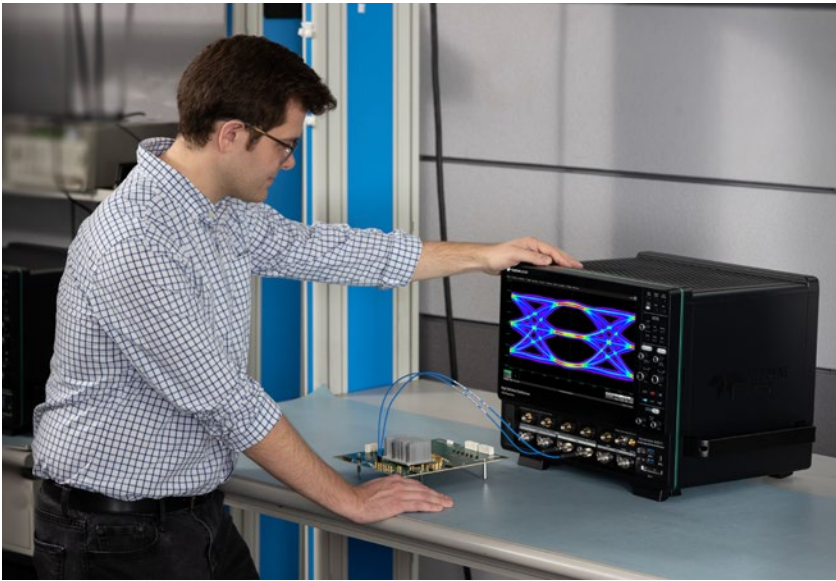

Characterization

Understanding device performance requires a unique combination of high signal fidelity and advanced analysis capability.

WaveMaster 8000HD's 12-bit resolution at up to 65 GHz bandwidth means pristine signal quality for high-speed signals.

SDA Expert eye, jitter and noise measurement for PAM and NRZ signals, coupled with a high-performance PC system, makes complex analysis easy and fast.



Automation

WaveMaster 8000HD offers powerful, flexible test automation tools and capabilities to improve workflow and minimize setup errors.

QualiPHY® automated test options improve repeatability and reduce test times for more efficient high-volume testing.

The best-in-class PC platform completes complex analysis processing tasks faster, resulting in better test throughput.



Compliance

Today's technologies impose strict requirements for characterization and compliance testing. WaveMaster 8000HD simplifies these workflows with QualiPHY test automation options for PCIe®, USB, DDR and more.

SDA Expert eye diagram, jitter and noise analysis with technology-specific measurement tools complements the compliance packages for deeper insight.

When test setups need troubleshooting, WaveMaster 8000HD's unique set of debug tools helps to quickly get back to making measurements.

TOTAL DEVELOPMENT CYCLE COVERAGE



Validation

Going beyond compliance means ensuring the device works as intended in all conditions.

WaveMaster 8000HD's 8 Gpts of memory on all four channels - the most of any oscilloscope - captures intermittent or one-off events which may only occur over long timespans.

Differential probes with up to 30 GHz bandwidth enable visibility into signals anywhere in the system under test.

Unique mixed-signal inputs capture and trigger on sideband signals without using up valuable analog inputs.

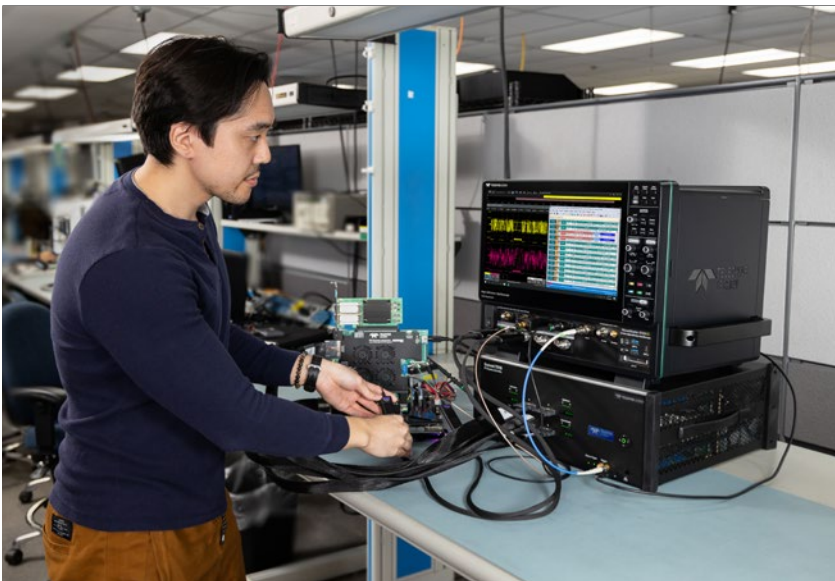

Integration

One of the most challenging problems in the development cycle occurs when two otherwise-compliant devices fail to interoperate correctly. The WaveMaster 8000HD was designed for this particular debug scenario.

CrossSync PHY software integration with Teledyne LeCroy protocol analyzers shows the entire protocol stack at once, while compatible interposers and test coupon fixtures simplify signal access in complex systems.

WaveMaster 8000HD's flexible inputs enable capturing all critical device signals: high-speed lines, power rails, digital sidebands and more.

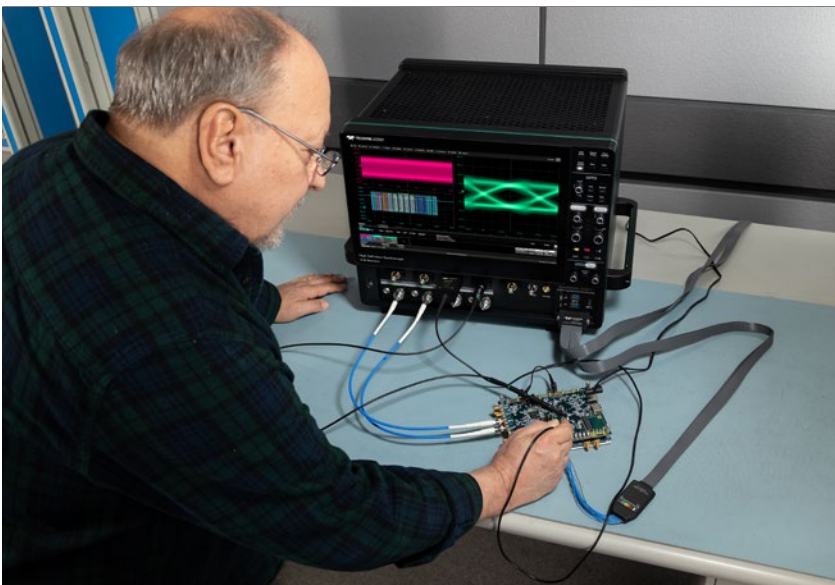

Debug

Debugging high-speed interfaces used to mean having two oscilloscopes on hand: one for high-speed characterization and one for embedded debug. WaveMaster 8000HD does it all, without compromise.

It has flexible inputs for capturing all critical device signals, using passive probes and current probes alongside high-speed analog inputs and digital signals.

Plus, WaveMaster 8000HD's industry-leading 8 Gpts acquisition memory option enables up to 100 ms capture time at full bandwidth.

PERFORMANCE

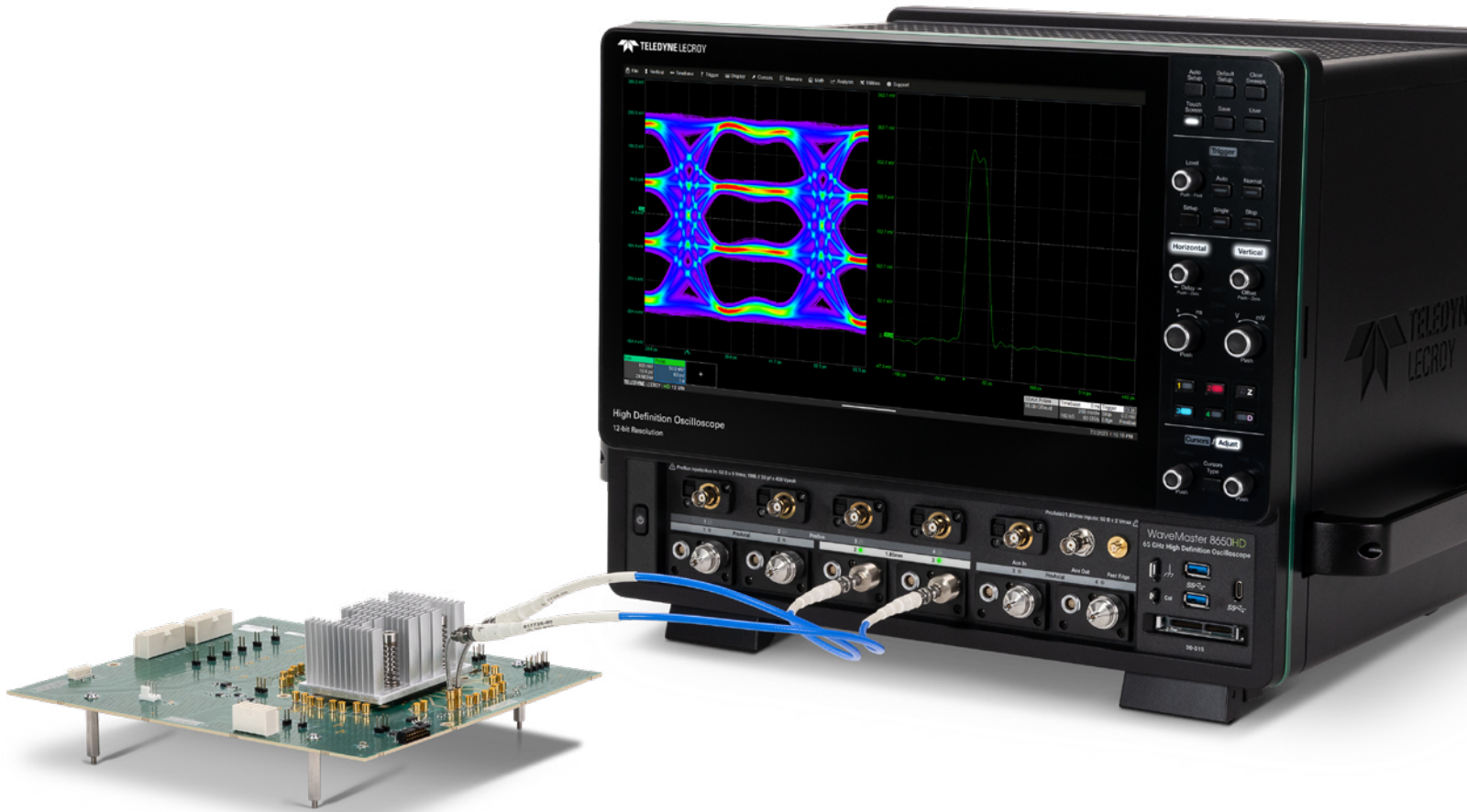

Modern serial data technologies require an oscilloscope with class-leading performance in more ways than ever. Faster signals are driving higher bandwidth requirements. New trends towards higher-order modulations like PAM3 and PAM4 mean that oscilloscope resolution is now a critical consideration. Complex analysis methodologies demand more computing power.

Up to 65 GHz at 320 GS/s

WaveMaster 8000HD has the bandwidth to acquire, visualize and characterize even the fastest serial data signals. Proven Digital Bandwidth Interleaving (DBI) technology seamlessly creates a pristine 65 GHz signal path.

12-bit Resolution

WaveMaster 8000HD provides 12-bit resolution all the time, at all sample rates. Its combination of vertical resolution and visibility into high-frequency effects enables it to capture every signal detail.

Fast Waveform Processing

Modern serial data technologies mandate measurement methodologies that can be computationally demanding. WaveMaster 8000HD includes a class-leading PC system, so less time is spent waiting for measurements to complete.

WAVEMASTER 8000HD AT A GLANCE



Key Attributes

- 1. 1.85 mm inputs up to 65 GHz bandwidth (on DBI models)
- 2. ProAxial inputs up to 33 GHz bandwidth
- 3. ProBus inputs up to 2 GHz bandwidth (50 Ω) and 500 MHz bandwidth (1 M Ω)
- 4. Mixed-signal input 2.5 GS/s
- 5. Up to 8 Gpts acquisition memory
- 6. 15.6" 1920 x 1080 Full HD capacitive touchscreen
- 7. MAUI® with OneTouch user interface for intuitive and efficient operation
- 8. Waveform control knobs
- 9. Color-coded panel indicators
- 10. Cursor/Adjust knobs
- 11. High-speed USB connectors
- 12. PC system with 64 GB RAM
- 13. HDMI® and DisplayPort™ connectors with 4k resolution
- 14. Removable solid-state hard drive
- 15. LBUS connector for HDA125 high-speed digital acquisition system
- 16. Reference Clock input/output
- 17. USBTMC over USB 3.1

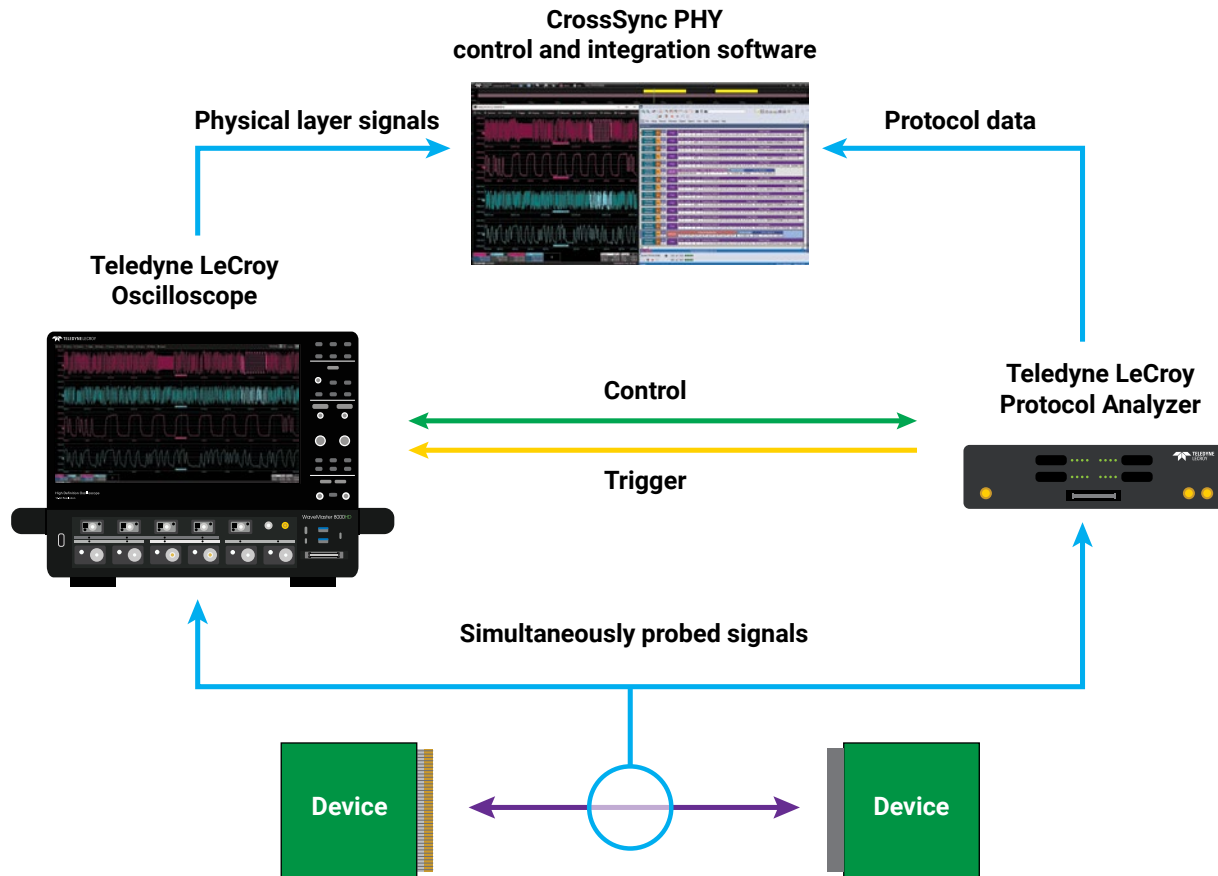

Interoperability issues can lead to finger-pointing exercises that cost money and delay time-to-market. **CrossSync PHY** technology merges the functions of a Teledyne LeCroy oscilloscope with a PCI Express or USB protocol analyzer for insight into link behavior that no other instrument can provide.

Validate and debug active link operation

- CrossSync PHY capable interposers and test coupon fixtures enable observation of both electrical and protocol behavior without disturbing the link
- Sideband signals, reference clock and power rails are all easily accessible to oscilloscope probes
- High-bandwidth oscilloscope probing points provide easy access to high-speed data lanes

Quickly resolve interoperability issues by capturing the entire protocol stack

- Trigger protocol analyzer and oscilloscope captures on the same high-level event
- Easily measure timing relationships between protocol and electrical domains
- Faster root-cause analysis means fewer costly finger-pointing exercises

Analyze link training with integrated physical and protocol views

- Observe electrical-level results of protocol-level commands
- Combined navigation means always knowing which protocol and electrical behaviors happen at the same time
- No single instrument can deliver this level of cross-layer insight into link training behavior

UNRIVALED DEBUG CAPABILITIES

The Longest Oscilloscope Acquisition Memory

Long memory and high sample rates capture both millisecond-scale trends and picosecond-scale glitches. With up to 8 Gpts of acquisition memory, WaveMaster 8000HD captures events occurring over long periods of time, while maintaining high sample rate for visibility into the smallest details, and always at 12 bits of resolution. Oscilloscopes with less memory require trading off sample rate for acquisition time.

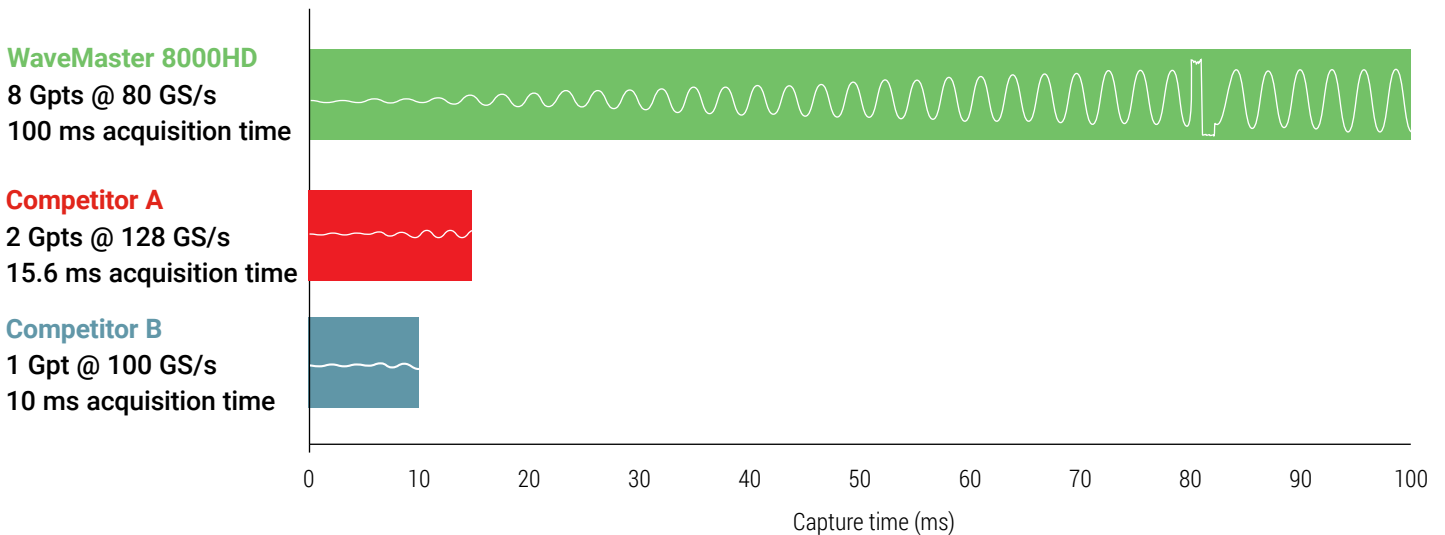

Comprehensive Embedded Debug Toolset

Debugging high-speed interfaces used to mean having two oscilloscopes on your bench – one high bandwidth oscilloscope and one general-purpose oscilloscope. WaveMaster 8000HD oscilloscopes do it all, without compromise.

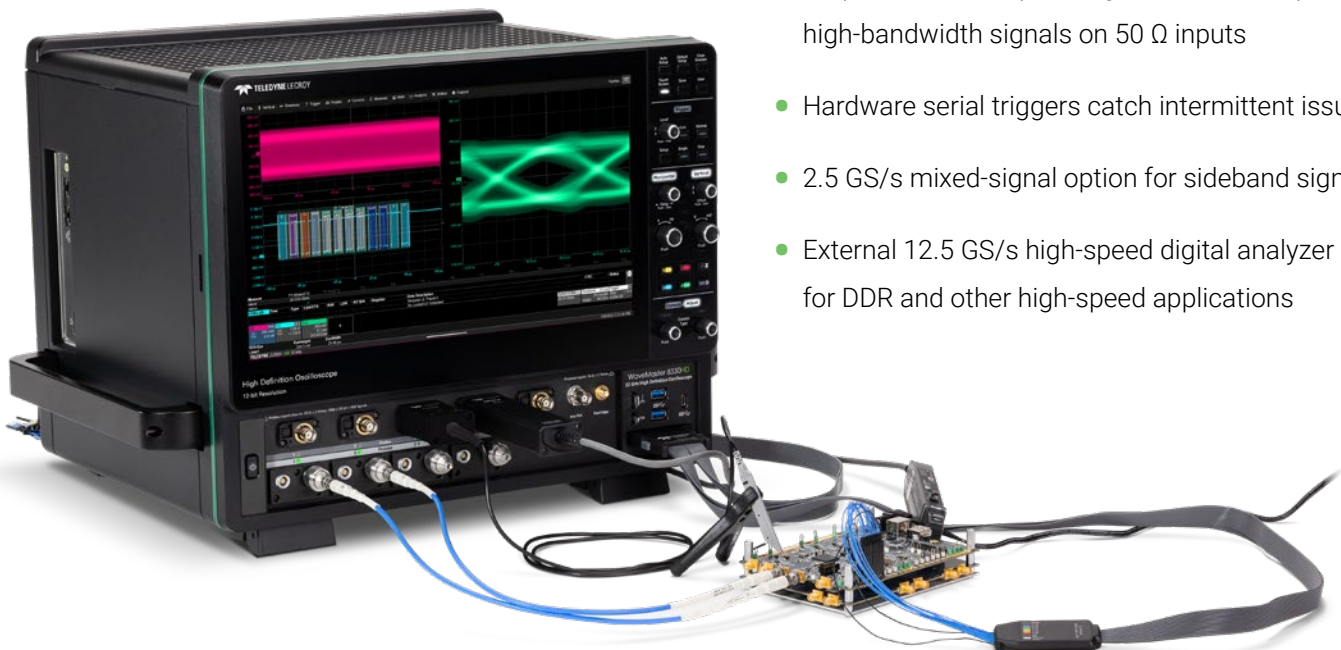

- Acquire both low-speed signals with 1 M Ω probes and high-bandwidth signals on 50 Ω inputs
- Hardware serial triggers catch intermittent issues
- 2.5 GS/s mixed-signal option for sideband signals
- External 12.5 GS/s high-speed digital analyzer option for DDR and other high-speed applications

SIMPLIFIED SERIAL DATA EXPERTISE

SDA Expert serial data analysis software is the first eye diagram and jitter analysis package with built-in technology expertise. It simplifies set up and expands debugging capabilities with tailored technology analysis for PCI Express, USB, DisplayPort and more.

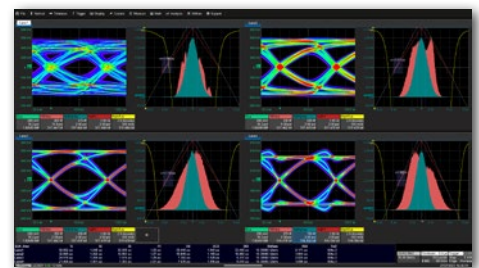
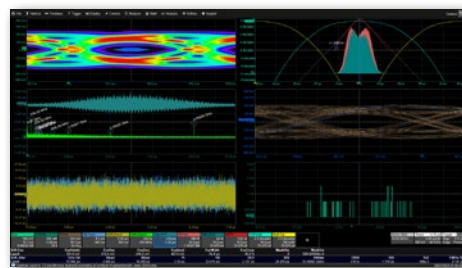
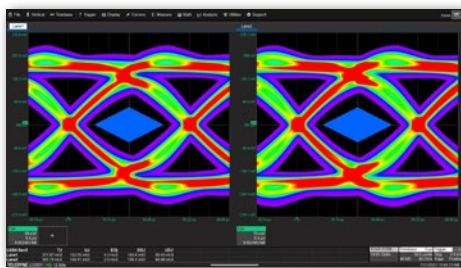
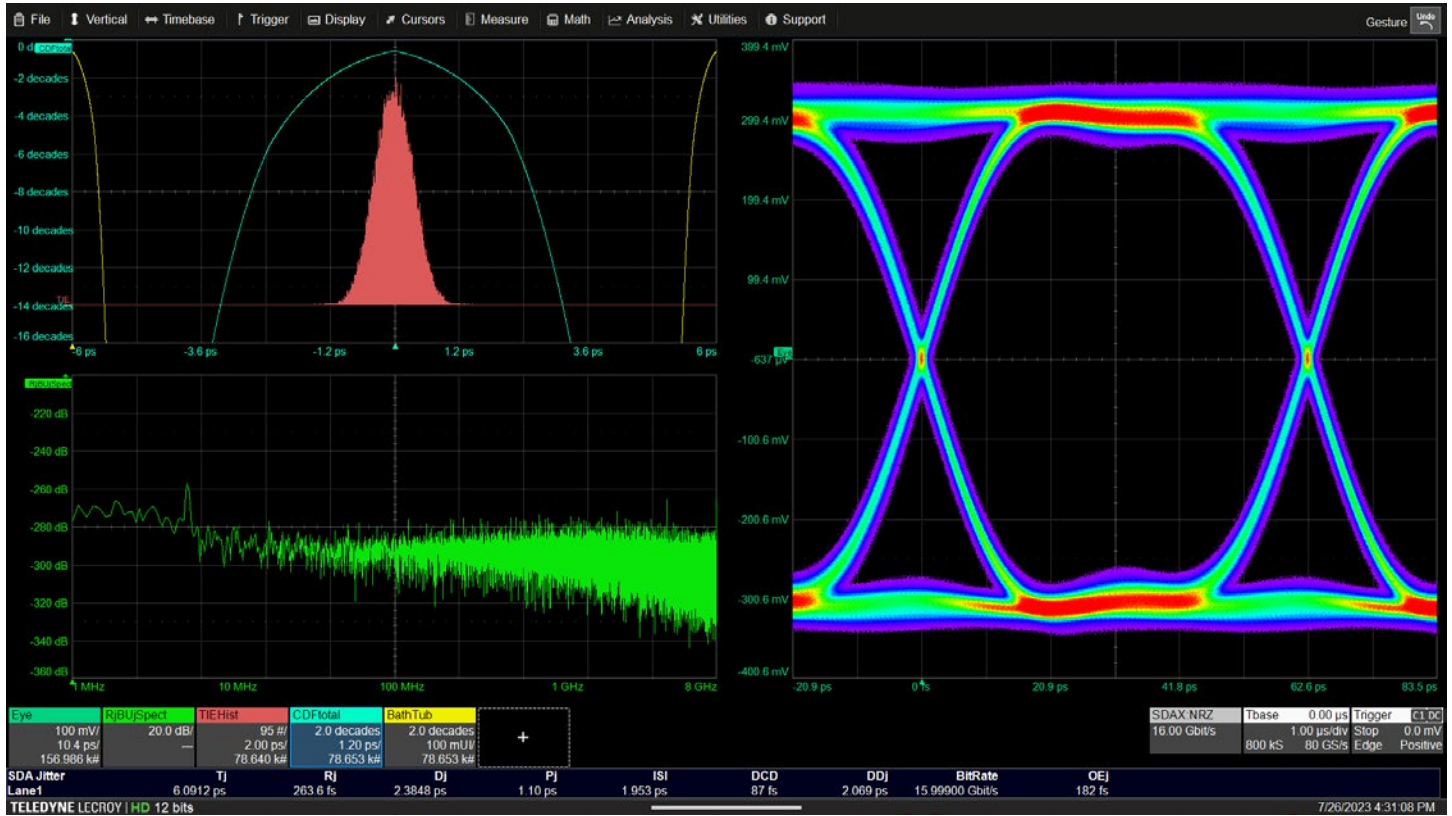

Tailored Technology Analysis for PCI Express, USB, DisplayPort and More

- Technology-specific measurement expertise is built in
- Seamlessly transition from compliance to debug
- Intuitive measurement selection saves time and avoids errors

Most Complete Serial Data Analysis Toolbox

- Fourth-generation toolset covers everything needed for NRZ and PAM signals
- Integrates everything – jitter, noise, crosstalk, equalization and pulse response
- Unique multi-view support with reference and comparison modes

Highest Confidence for Complex Measurements

- One button set up saves time and avoids errors
- Technology selections simplify the set up of complex measurements
- Quickly document results and save data with built-in report generator

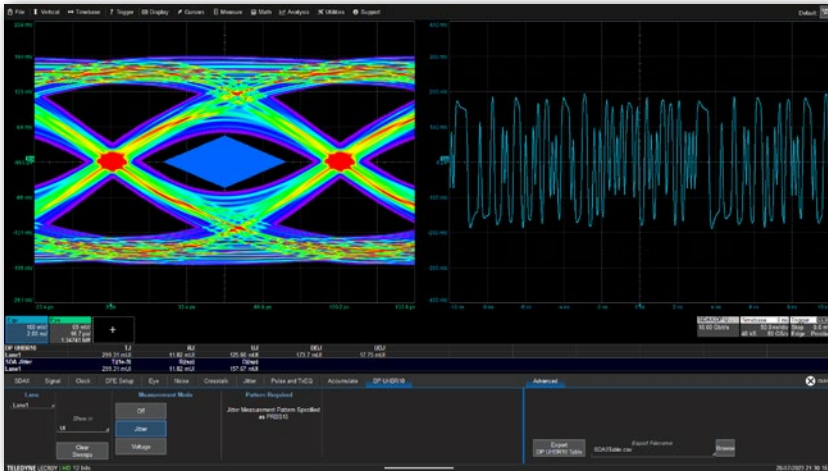

Technology-specific Analysis

- Predefined technology framework with added options simplifies measurement set up
- Dynamic graphical visualization of channel and test point setup
- Pre-defined test points simplify setup and avoid errors
- Easily make measurements exactly as defined in the technology standards

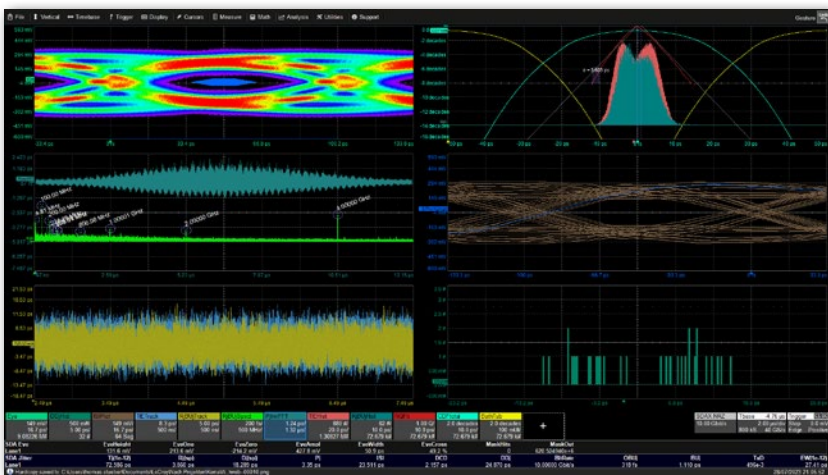

NRZ Analysis

- Comprehensive jitter decomposition, eye diagram and analysis capabilities
- Advanced signal integrity tools for embedding, de-embedding and equalization emulation
- Integrates jitter, noise, crosstalk, equalization and pulse response in one workflow
- Comprehensive jitter decomposition and analysis

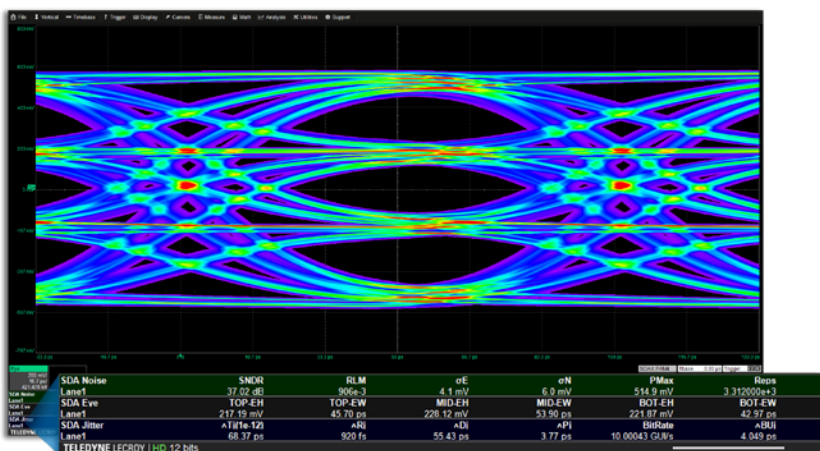

PAM Analysis

- Comprehensive PAM3 and PAM4 eye diagram, jitter and noise measurements
- Analysis of random, deterministic and periodic impairments for each eye opening
- Most complete SNDR and RLM analysis
- Powerful visualization tools for identifying unexpected noise and distortion components
- Comprehensive jitter and noise breakdown capability

ANALYZE THE WHOLE LINK

Combining the WavePulser® 40iX High-speed Interconnect Analyzer, WaveMaster 8000HD oscilloscope and SDA Expert options gives the most complete signal integrity analysis toolkit available. Quickly characterize the entire signal path from transmitter to receiver, acquire high-fidelity waveforms at a convenient test point, then easily analyze the signal at any point of interest.

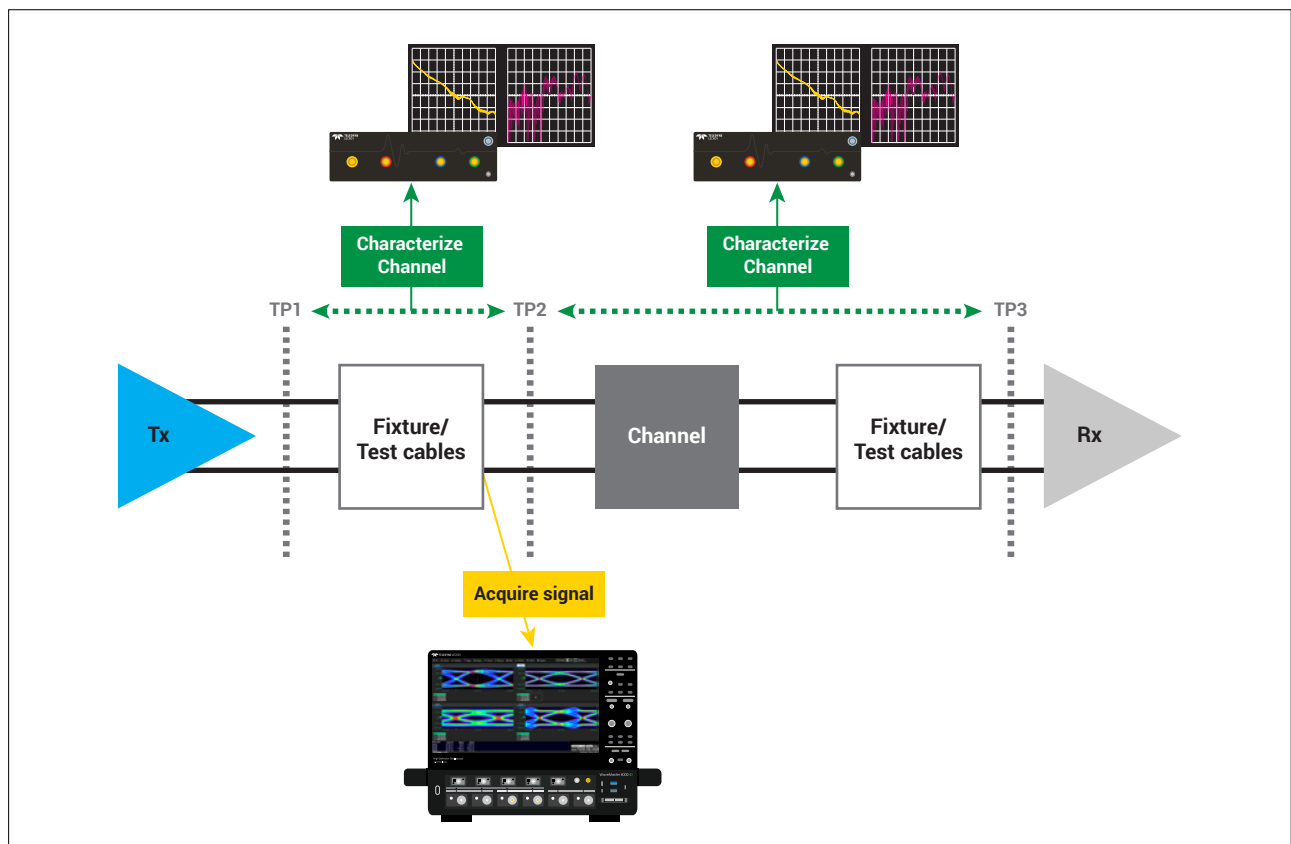

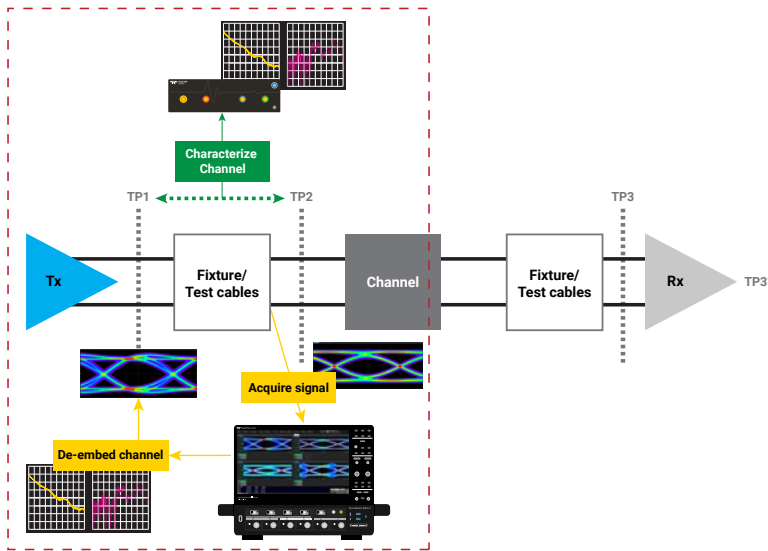

De-embed Fixtures and Test Cables

- Measure S-parameter models using WavePulser 40iX, or import from other files or simulation tools
- Sophisticated Eye Doctor and VirtualProbe tools easily and accurately remove the effects of fixtures and cables from acquired oscilloscope waveforms
- Apply the full SDA Expert Complete toolkit to de-embedded waveforms for full eye, jitter and noise analysis directly at the output pins of the device under test

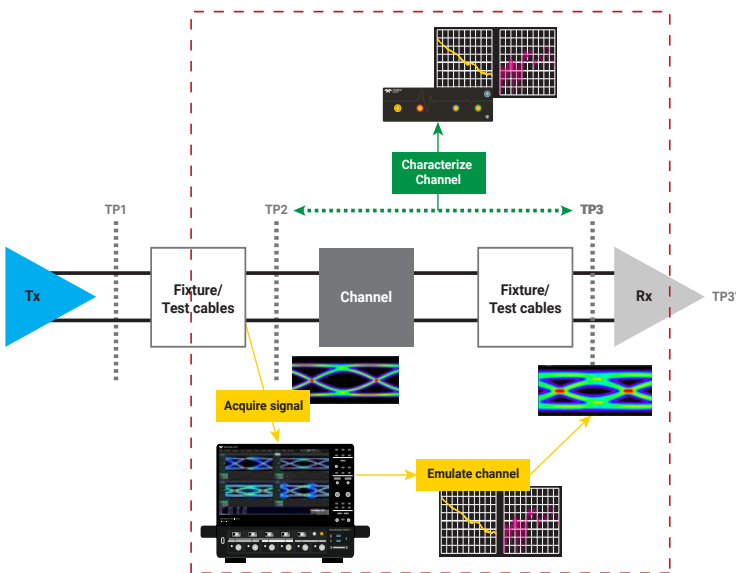

Emulate Real-world Channel Losses

- WavePulser 40iX simplifies and speeds up accurate measurements of test channel loss profiles
- Channel model s-parameter files can be easily imported from the WavePulser 40iX or elsewhere into Eye Doctor and VirtualProbe tools in the oscilloscope
- Acquire waveforms at any point in the signal path, then use VirtualProbe to cleanly embed the effects of the channel
- Use the full analysis capability of SDA Expert Complete to compare eye, jitter and noise measurements at multiple test points simultaneously

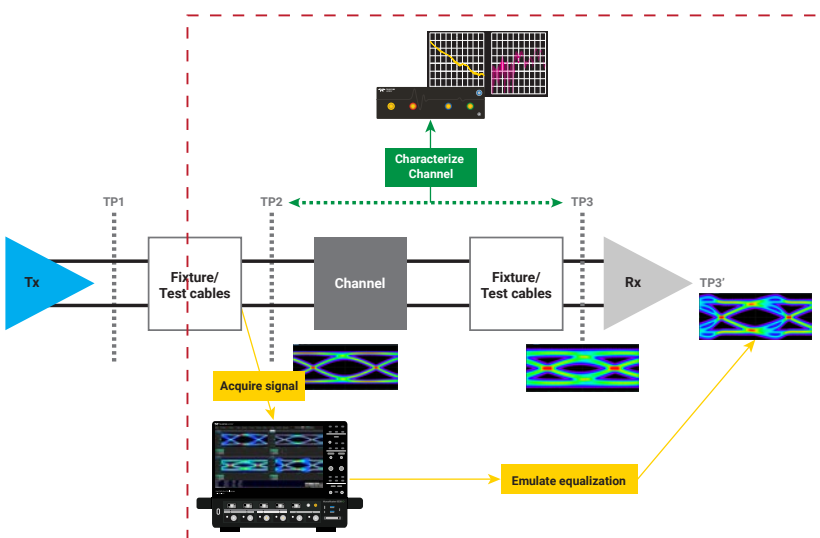

Emulate Transmitter and Receiver Equalization

- SDA Expert Complete with Eye Doctor enables the emulation of all common equalization types, including:
 - Transmitter emphasis
 - Receiver FFE
 - Receiver CTLE
 - Receiver DFE

PCI EXPRESS® TESTING THAT CROSSES THE LAYERS

Teledyne LeCroy is the only company that provides PCIe® testing across the layers – protocol to physical – while also providing superior instruments with sophisticated jitter, eye diagram, debug and compliance software.

- Automated transmitter, receiver and link equalization (LEQ) testing with QualiPHY software options
- Visibility from physical layer through protocol operations
- Teledyne LeCroy is gold suite certified for all relevant PCI Express electrical compliance tests

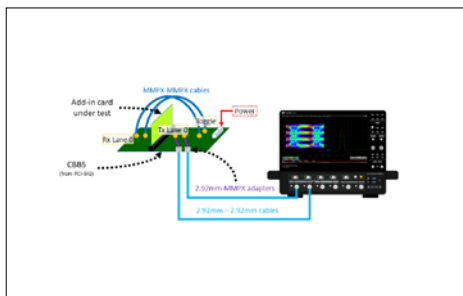
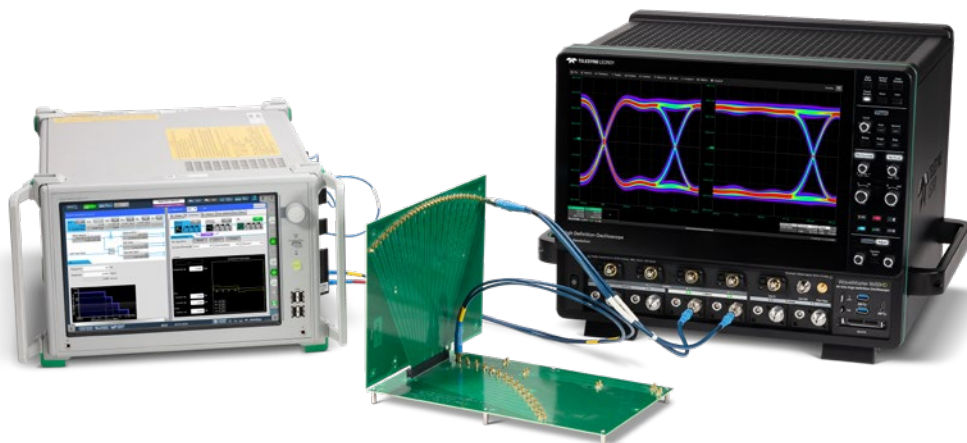

Transmitter (Tx) Testing

- Base specification and compliance testing for add-in cards and systems in CEM, M.2 and U.2 form factors
- QualiPHY fully automates collection and processing of transmitter waveforms
- Supports TF-PCIE4-CTRL controller for full fixture and DUT automation
- Debug electrical compliance issues faster with SDA Expert software

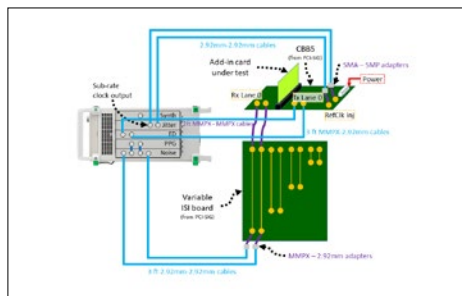

Receiver (Rx) Testing

- Receiver calibration and testing using the WaveMaster 8000HD and Anritsu MP1900A BERT
- QualiPHY controls both the WaveMaster 8000HD and MP1900A
- Use WavePulser 40ix for receiver channel characterization and calibration
- Single QualiPHY user interface for Tx and Rx testing

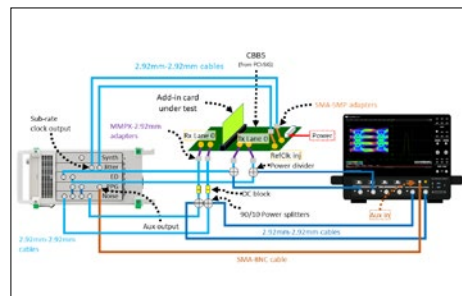

Link Equalization (LEQ) Testing

- Fully automated Tx and Rx LEQ testing using QualiPHY with SigTest integration
- Test fixture and DUT automation for fast throughput
- Go directly from compliance test to cross-layer debug using ProtoSync on the WaveMaster 8000HD and LTSSM analysis on the MP1900A
- Link the WaveMaster 8000HD with a protocol analyzer using CrossSync PHY for deeper interoperability debug

Simplified PCIe Link Testing with CrossSync PHY

- Validate and debug active link operation
- Quickly resolve interoperability issues by capturing the entire protocol stack
- Analyze PCIe link training with integrated physical and protocol views



Most Confidence for PCIe Testing

- Solutions for all PCIe compliance tests and CXL compliance tests
- Fully automated transmitter, receiver and link equalization testing
- Easily transition from PCIe compliance testing to debug with SDA Expert

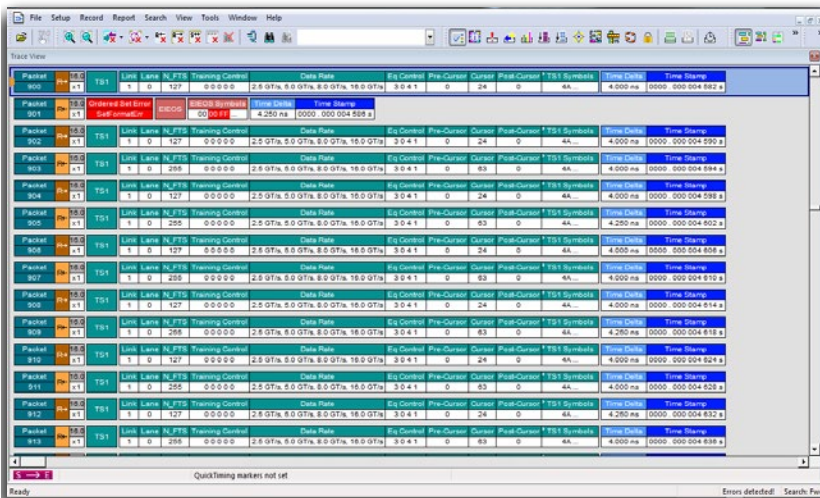

Built-in PCIe Expertise Using SDA Expert

- Comprehensive eye diagram, jitter and other PCIe measurements
- Simple, powerful transmitter equalization analysis
- Most complete Signal-to-Noise-and-Distortion Ratio (SNDR) analysis



THE BEST OSCILLOSCOPE FOR USB-C TECHNOLOGY TESTING

The WaveMaster 8000HD oscilloscope combines high-speed and sideband testing into a single instrument, making it the only oscilloscope that performs PHY compliance testing *and* gives you the power to go beyond compliance to debug USB Type-C® system interoperability failures.

Complete PHY and PHY-logic layer oscilloscope solutions for USB4®, Thunderbolt™, USB 3.2/2.0, DisplayPort 2.1 and USB Power Delivery, all over the USB Type-C Connector.

- USB-IF and VESA approved compliance software
- Built-in USB-C test expertise for measuring and characterizing signals
- Simplify USB-C link testing with cross-layer analysis

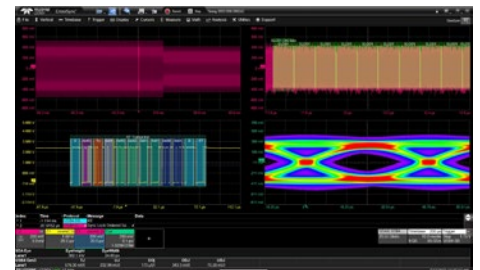
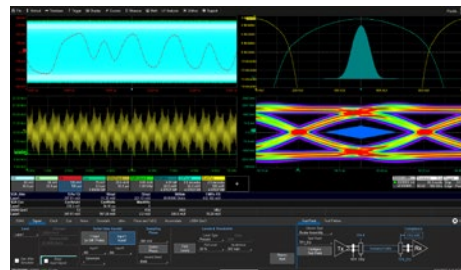
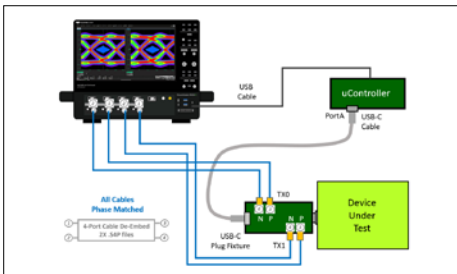

Fastest PHY Compliance

- QualiPHY software automates all Multi-lane USB-C transmitter (Tx) and receiver (Rx) compliance tests using a single, friendly user interface
- Fully automated, easy to set up testing
- USB4 SigTest automation without transferring waveforms to a PC
- Accurate Rx calibration and BER testing with Anritsu MP1900 BERT

Built-in SDA Expert Analysis

- Teledyne LeCroy builds decades of industry standard expertise into SDA Expert serial data analysis software. Simply:
 1. Select the standard under test
 2. Configure the desired test point
 3. Enable standard-specific measurements
- WavePulser 40iX simplifies and speeds up receiver channel characterization and calibration

Cross-layer Analysis

- See the whole link with CrossSync PHY for USB4 and Thunderbolt
- Trigger on USB4 sideband messages using USB4-SB TDMP, and debug high-speed with USB4bus DME
- High-speed serial decode and analysis using USB32 bus D, USB2bus TDME and ProtoSync software
- Sideband and power delivery debug using USB-PD TDMP and DisplayPort-AUX DMP

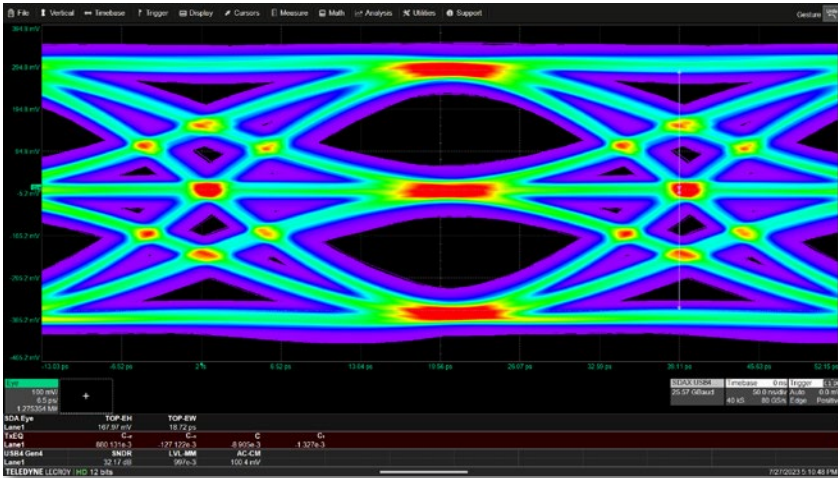

USB Type-C PHY Compliance

- QPHY-USB4-TX-RX and QPHY-DP20-SOURCE/SINK automate transmitter and receiver compliance testing for USB4 version 2.0 and DisplayPort 2.1 standards, data rates ranging from 10 Gb/s NRZ up to 40 Gb/s PAM3
- Integrates USB4 ETT, USB4 Controller and SigTest Analysis for USB4, while also supporting 3rd-party fixtures and AUX controllers for DisplayPort over USB-C testing
- Fully automates receiver calibration and test with the Anritsu MP1900A high-speed BERT

Legacy Connector PHY Compliance

- QPHY-USB3.2-TX-RX, QPHY-USB and QPHY-DP20-SOURCE/SINK automate transmitter and receiver compliance testing for not only USB-C but all other connectors and data rates
- Supports all approved test fixtures, multiple test generators and DUT controllers for automated device control



USB-C System Level Debug

The TF-USB-C High-speed and Sideband Test Coupon Fixture provides signal access at the USB-C connector for cross-layer analysis.

1. Transparent signal path through plug, receptacle and C-C cable
2. Vbus (voltage and current) and sideband signal access using passive and active probes
3. High-speed TX/RX signal access using DH series active differential probes

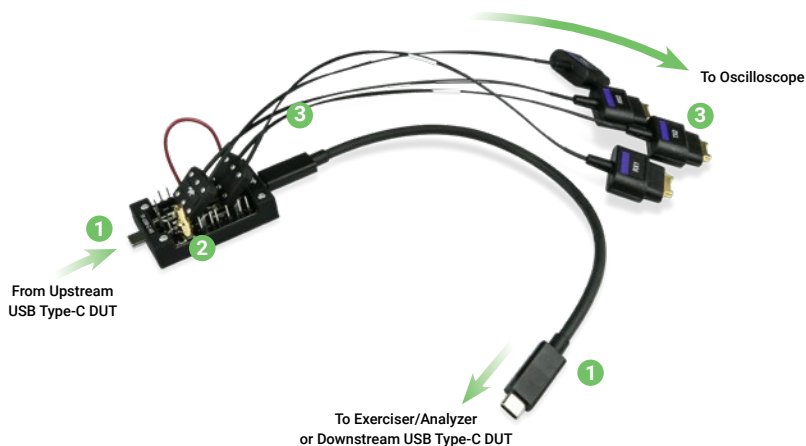

FASTEST DDR TEST JOURNEY

The DDR test path can be quickly traveled when the right tools are designed for engineers. This enables smooth transitions between different stages of design: from DDR turn-on and initial validation testing to fine-tuning, optimizing and pre-compliance. Accelerating testing confidence enables compliance tests to be done quickly and easily. Teledyne LeCroy covers JEDEC standards DDR2/3/3L/4/5 and LPDDR2/3/4/4X.



1. Interposers and Probes

- Interposers from reliable partners
- DH series probes with solder-in tips

2. External Mixed-signal “Logic Analyzer”

- Market’s only trigger & decode up to DDR5
- Validate 20+ Command Address packets
- Highest accuracy for Read/Write separation

3. Tools for Turn-on Through Pre-compliance

- Multi-scenario viewing fast-tracks testing
- Exclusive toolkit with JEDEC defined measurements
- Eliminate signal quality errors with virtual probing

4. Automated DDR Compliance Testing

- Measure to the latest JEDEC specification
- Increase repeatability & test consistency
- Save Pass/Fail reports with screenshots

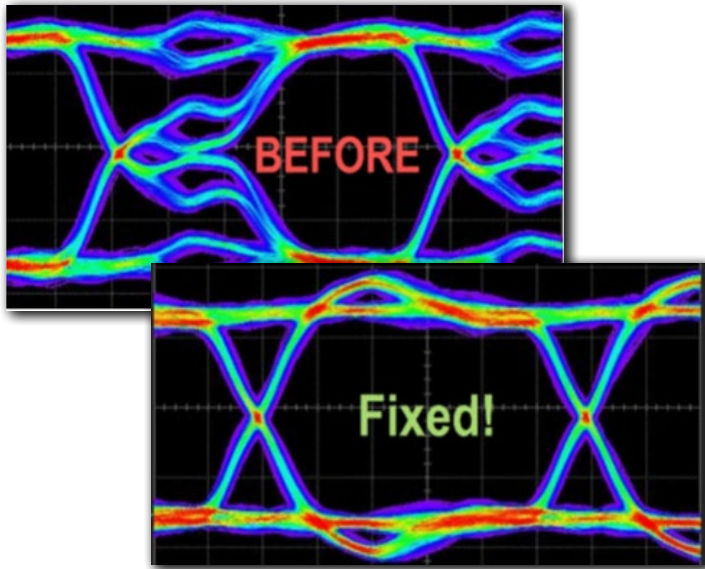

Maximize Turn-on and Validation Testing Stages

Establishing basic operation, signal checks and responses is the foundation of board turn-ons: knowing signals look correct, command bus is communicating and Read/Write packets are present.

- DDR Debug Toolkit enables basic JEDEC measurements across multiple Read/Write packets
- The HDA125 High-speed Digital Analyzer enables decode, trigger and packet validation
- VirtualProbe corrects probe locations, interposers, reflections, termination errors

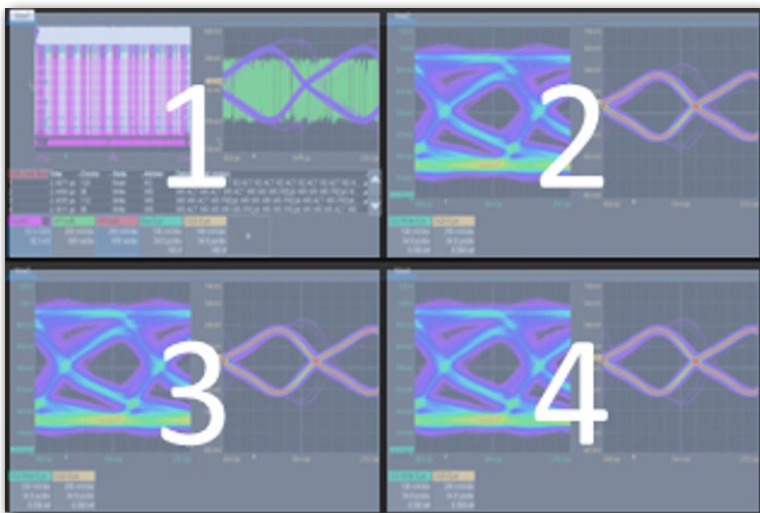

Accelerate Pre-Compliance Testing and Fine-Tuning Stages

DDR stability occurs when the DRAM has been fine-tuned and optimized. This occurs when the voltage and timing parameters have adjusted and measured for peak performance.

- Fast-track optimization and tuning stages with four different multi-scenario views
- Interactively perform eye, mask and JEDEC-specific measurements on Read or Write packets, in each view
- HDA125 enables the highest accuracy for Read/Write separation.

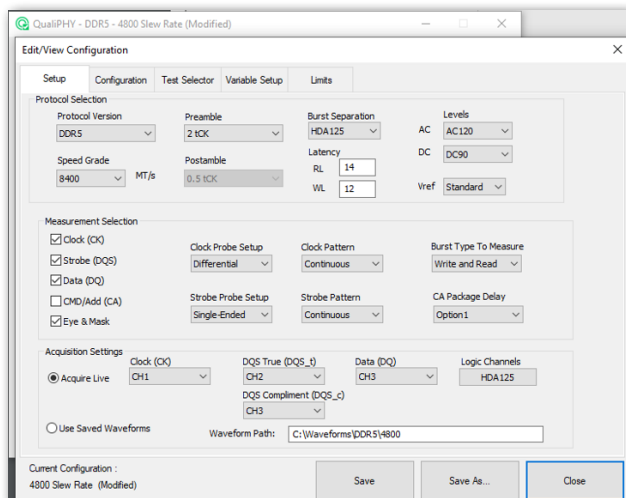

Automated DDR Compliance Testing

Automated compliance testing enables faster test times by reducing inconsistencies and testing to the JEDEC standard; users can quickly stop and do root-cause analysis of failures with the DDR Debug Toolkit.

- JEDEC measurements for DQ, DQS, CK, CA signals
- Supports complete testing at BGA
- Pass & Fail reports with annotated screenshots
- Analyze compliance failures in a dedicated Debug Toolkit

QUALIPHY AUTOMATED SOFTWARE TEST FRAMEWORK

QualiPHY is Teledyne LeCroy's automated software test framework for performing standardized tests on high-speed serial interfaces. QualiPHY automation software is available for PCI Express, USB, DDR, DisplayPort, HDMI and other technologies - for a full list, see our **Oscilloscope Features, Options, and Accessories catalog**.

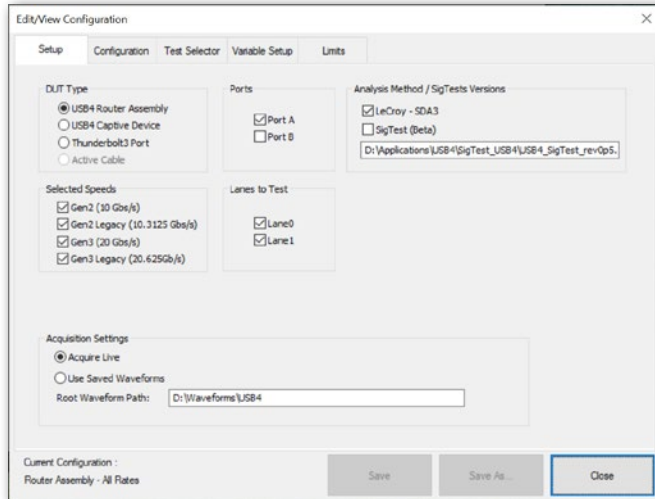

Simplified Set Up

QualiPHY dialogs help the user configure all aspects of test execution, including:

- Selecting the set of tests to run
- Configuring test parameters
- Customizing limits
- Options to stop after each test or execute sequentially

Streamlined Test Execution

QualiPHY guides the user through connection and execution of each test, resulting in increased repeatability.

- Clear, informative connection diagrams help simplify complex test setups and reduce mistakes
- Dialogs explain test execution and required Device Under Test (DUT) settings
- Simple, powerful Host Program Control interface enables complete automation of QualiPHY with external scripting environments (for selected QualiPHY products)

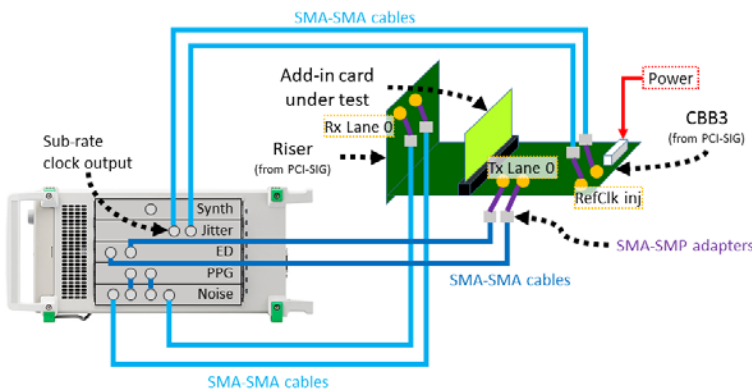

Informative Reporting

QualiPHY produces comprehensive reports documenting test results.

- Save reports in PDF or HTML format
- Screenshots and tabular results included
- Summary table at the start of the report makes it easy to tell pass/fail results at a glance

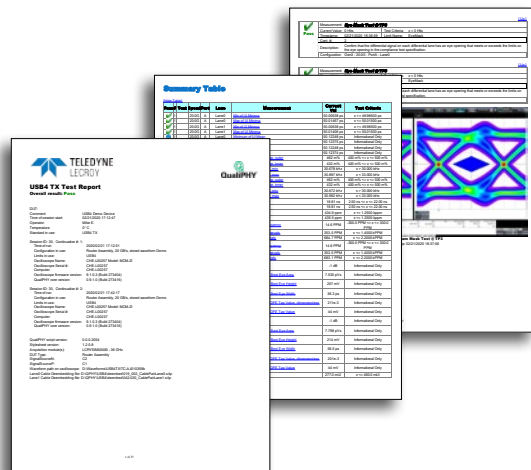

COMPREHENSIVE LOW-SPEED SERIAL SOLUTIONS

Teledyne LeCroy's Trigger (T), Decode (D), Measure/Graph (M) and Eye Diagram (E) or Physical Layer (P) options are the best of their kind. Visit teledynelecroy.com/tdme for complete details.

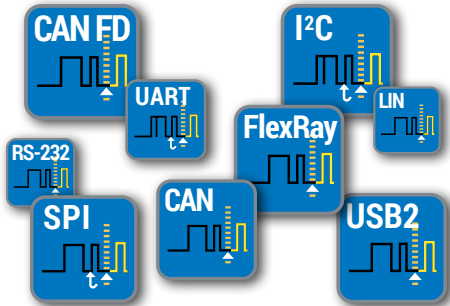

Highest Performance Triggers

Designed by people who know the standards, with the unique capabilities you need to isolate unusual events.

- Powerful, flexible, unique
- Conditional data setup
- Support for proprietary protocols



The Most Intuitive Serial Decoder

Decoded protocol information is marked by transparent, colored overlays for an intuitive, easy-to-understand visual record. Navigate the decoding using a single, time-interleaved table with "touch to zoom."

- Intuitive, color-coded overlays
- Pattern search
- Interactive table summarizes results

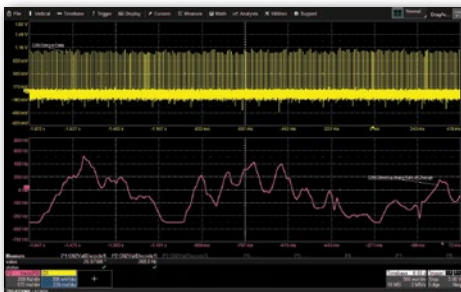

Measure and Graph Tools for Validation Efficiency

Automated timing measurements quickly validate cause and effect and serial data digital-to-analog (DAC) converter enhances understanding.

- Automated timing measurements
- Serial data DAC and graphing tools
- Bus status measurements

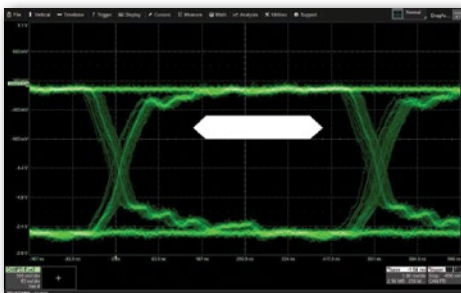

Eye Diagrams and Physical Layer Testing

Rapidly display an eye diagram of low-speed serial data signals. Eye parameters quantify system performance, and eye masks identify anomalies.

- Up to four simultaneous eye diagrams
- Eye measurements and masks
- Advanced PHY measurements

HIGH BANDWIDTH DIFFERENTIAL PROBES

The DH series of 8 to 30 GHz active differential probes provides high input dynamic range, large offset capability, low loading and excellent signal fidelity with a range of connection options.

General Purpose Probing up to 30 GHz

Teledyne LeCroy's DH series 8 GHz to 30 GHz differential probes offer the combination of bandwidth, input range and offset capability to address any high-speed probing requirement - from debugging serial data interfaces to validating DDR memory systems.

Exceptional Signal Fidelity

DH series probes provide superior loading characteristics and are calibrated with a custom "fine-tuned" frequency response. The ultra-low loading and flat frequency response ensure accurate measurements.

Wide Variety of Tips

Two 30 GHz solder-in leads let you choose between a 3.5 Vpp input range for general-purpose applications, or high sensitivity with exceptionally low noise. Also available are a 1-meter long 16 GHz high-temperature tip, a 16 GHz handheld browser tip and an 8 GHz QuickLink adapter for connecting mixed-signal probe tips.



Tip Identification

Each DH series tip has its own data onboard - the oscilloscope software automatically selects the correct tip type and precisely corrects for its effects. The result is superior signal fidelity and superior ease-of-use.

Digital Logic Probing Options

HDA125 High-speed Digital Analyzer

The HDA125 turns your Teledyne LeCroy oscilloscope into the highest-performance, most flexible mixed-signal solution with 12.5 GS/s digital sampling rate (3 GHz digital clock rate) on 18 input channels and the QuickLink probing solution. Ideal for validation of DDR interfaces.



BROAD RANGE OF PROBING SOLUTIONS

WaveMaster 8000HD oscilloscopes support a broad range of probes for a variety of applications.

Differential Probes (200 MHz – 1.5 GHz)



Wide dynamic range, low loading and excellent noise performance. From 200 MHz to 1.5 GHz. Specialty AP033 provides 10x gain and high CMRR.

Differential Probes (4 – 6 GHz)



5 Vp-p dynamic range with ± 3 V offset and low noise and loading. Solder-in, browser, QuickLink, Quick Connect, square pin and HiTemp leads/tips.

Differential Probes (8 – 30 GHz)



For serial data, DDR or other high-speed signals. Standard and high-sensitivity solder-in, HiTemp, and QuickLink for mixed-signal probing.

60 V Common Mode Differential Probes



The ideal probes for lower voltage GaN power conversion measurement with the highest accuracy, best CMRR and lowest noise. Up to 1 GHz.

High Voltage Differential Probes



1 kV, 2 kV and 6 kV CAT safety rated models. Widest differential voltage ranges, exceptional CMRR, low noise, 1% gain accuracy.

High Voltage Optically Isolated Probes



Ideal for GaN and SiC devices. Highest accuracy, most bandwidth, wide range of voltages, optical isolation.

High Voltage Passive Probes



1 kV to 6 kV ratings. Provides ground-referenced high voltage measurements for a wide range of applications.

Active Voltage Probes



1 to 4 GHz models. High signal fidelity and low circuit loading (< 1 pF tip capacitance), ± 8 V dynamic range, ± 12 V offset.

Active Voltage/Power Rail Probe



4 GHz bandwidth, ± 60 V offset, ± 800 mV dynamic range. High DC input impedance and low noise/attenuation for power rail probing.

Current Probes



For AC, DC and impulse current measurements. Utilizes combination of Hall effect and transformer technology. Up to 500 A, up to 100 MHz.

Rogowski Coil Probes



Wide frequency range and small sense coils for maximum flexibility. From 300 to 6000 Amps, as low as 0.1 Hz to as high as 30 MHz.

Transmission Line Probes



High-bandwidth passive probe for use with 50 Ω inputs. DC to 7.5 GHz with 0.25 pF input capacitance. 10x or 20x attenuation.

Probe and Current Sensor Adapters



Change between the different Teledyne LeCroy Oscilloscope input types or provide a simple interface to 3rd-party probes.

Passive Probes



10x attenuating with 10 M Ω input resistance. Ideal for low-frequency signals.

POWERFUL, DEEP TOOLBOX

Capture		View			Measure		Math		Analyze										Document
Triggering	Acquire	Display Grids	Display Views	Zooming	Parameters	Parameter Analysis	Functions	Advanced Functions	Pass/Fail	Anomaly Detection	Serial Decode	Serial Message Analysis	Clock & Timing Jitter	Serial Data Jitter	Serial Data Analysis	Application Packages	Document		
1 Exclusion	2 Measurement	3 5 MS/s Roll	4	5	6	7	8	9	10	11 Multistage	12 Sequence Mode	13 Protocol Table	14 Jitter Overlay	15 TJ, RJ, DJ	16 PAM-4 Analysis	17-22 Motor + Power	23 Compliance		
24 Analog-Digital	25 80ch 4 to 80 Channels	26 Multi-Grid	27 Segment	28 Multi-Zoom	29 All Instance	30 Statistics	31 Full Memory FFT	32 Digital Filters	33 Mask Test	34 TriggerScan	35 Symbol	36 Search & Zoom	37 Jitter Track	38 Bathtub Curve	39 RJ + BUJ Views	40-45 DDR Analysis	46 WaveStudio		
47 Serial Data	48 HD 4096 High Definition Technology	49 Drag and Drop	50 Waveform Histogram	51 Vertical Zoom	52 Parameter Math	53 Parameter Acceptance	54 Tracks / Trends	55 Processing Web	56 Actions	57 WaveScan	58 Protocol Layer	59 Bus Parameters	60 Jitter Histogram	61 IsoBER	62 DJ Views	63-67	68 LSB		
69 100 GHz / DBI	70 Q-Scope	71 3D Persistence	72 Auto-Scroll	73 Custom Measure	74 Histogram/Histogram	75 Demodulation	76 Custom Math	77 Boolean Compare	78 History Mode	79 RPM=1368	80 Application Layer	81 Timing Parameters	82 Jitter Spectrum	83 Jitter Simulation	84 Noise + Crosstalk	85-89	90 LabNotebook		
91	92	93	94	95	96	97	98	99	100	101	102 ProtoSync	103 Serial DAC Waveform	104 JitKit Views	105 EyeDr / VP	106 VectorLinQ VSA	107-114	115 Automation		
117 Device Loss	118 Mod Control Loop	119 Harmonics	120 3-Phase	121 Static+Dynamic	122 Zoom+Gate	123	124	125	126	127	128	129	130 Ethernet	131 DDR	132 Video	133 mipi	134		
140 R/W Separation	141 Multi-Eye View	142 DDR TJ, RJ, DJ	143 Debug Toolkit	144 Virtual Probe	145	146	147	148	149	150	151 Automotive	152 PCI EXPRESS	153 USB	154 Storage					

Element Key:

- ▲ Invented by LeCroy
- ★ Unique to LeCroy

Our Heritage

Teledyne LeCroy's 50+ year heritage is in processing long records to extract meaningful insight. We invented the digital oscilloscope and many of the additional wavelshape analysis tools.

Our Obsession

Our tools and operating philosophy are standardized across much of our product line. This deep toolbox inspires insight; and your moment of insight is our reward.

Our Invitation

Our Periodic Table of Oscilloscope Tools explains the toolsets that Teledyne LeCroy has deployed in our oscilloscopes. Visit our interactive website to learn more about them.

teledynelecroy.com/tools

MAUI STUDIO - WORKS WHERE YOU ARE

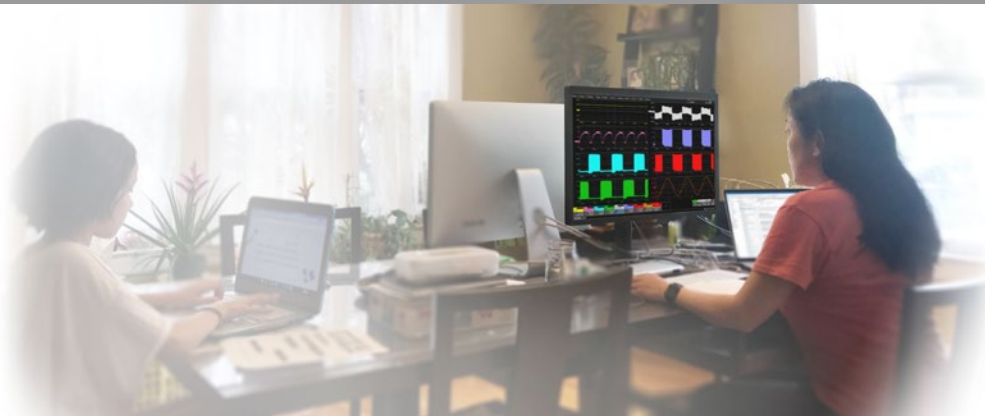

Unleash the power of a Teledyne LeCroy oscilloscope anywhere, using a PC with MAUI Studio Pro. Work remotely from your oscilloscope and collaborate with ease.

Flexibility to Work Anywhere

MAUI Studio provides the flexibility to work remotely. It allows anyone, anywhere to execute real-time analysis by connecting to an oscilloscope through an Ethernet connection or by analyzing a saved LabNotebook.

Collaborate with Ease

Using MAUI Studio, you can share a LabNotebook file saved from an oscilloscope with all your colleagues, and everyone will have access to the same software options that are found on your oscilloscope.

The Power of MAUI Studio

Get all the unbelievable analytical capabilities of your oscilloscope on your PC. MAUI Studio has all the tools needed to analyze complex waveform data, enabling your lab's oscilloscopes to be freed up for other activities.

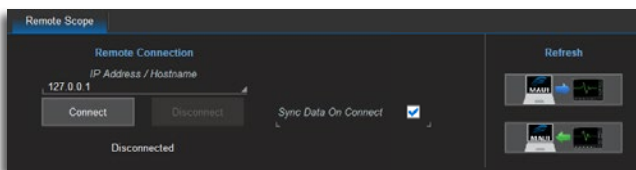

Remote Connection

- Connect to an oscilloscope through an Ethernet connection
- Transfer waveforms and setups from an oscilloscope to MAUI Studio Pro
- Transfer setups from MAUI Studio Pro to an oscilloscope
- Import software options by establishing a remote connection to an oscilloscope

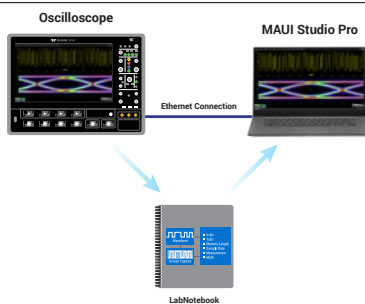

Offline Analysis

- Recall a LabNotebook file to analyze saved waveforms, measurements and setups
- Import software options by recalling a LabNotebook file
- Have access to the same software found on your oscilloscope

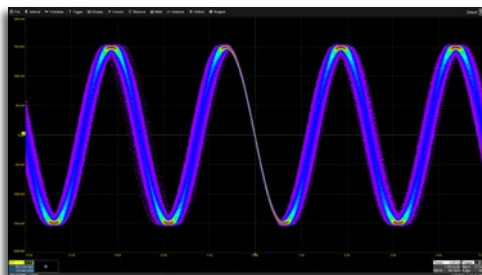

Arbitrary Function Generator

- Generate advance waveforms using the AFG
- Easily generate a PAM4 signal
- Add jitter to a clock signal to simulate real-world signal integrity impairments

Try the free MAUI Studio Pro 30 day trial. Download and register at teledynelecroy.com/mauistudio.

SPECIFICATIONS

	WaveMaster/SDA 8200HD	WaveMaster/SDA 8250HD	WaveMaster/SDA 8330HD
Vertical System			
Analog Bandwidth @ 50 Ω (-3 dB) (ProLink/ProAxial Input)	20 GHz (≥ 5 mV/div) ProLink input connectors	25 GHz (≥ 5 mV/div) ProAxial input connectors	33 GHz (≥ 5 mV/div) ProAxial input connectors
Analog Bandwidth @ 50 Ω (-3 dB) (ProBus Input)	2 GHz (≥ 10 mV/div)		
Analog Bandwidth @ 1 M Ω (-3 dB) (ProBus Input)	500 MHz (typical, ≥ 2 mV/div)		
Rise Time (10–90%, 50 Ω - typical)	19.1 ps (flatness mode)	15.9 ps (flatness mode)	12.6 ps (flatness mode)
Rise Time (20–80%, 50 Ω - typical)	13.2 ps (flatness mode)	10.3 ps (flatness mode)	7.8 ps (flatness mode)
Input Channels	4 (Any combination of ProLink and ProBus inputs)	4 (Any combination of 25 GHz ProAxial inputs or 2 GHz ProBus inputs)	
Vertical Resolution	12 bits; up to 15 bits with enhanced resolution (ERES)		
Vertical Noise Floor (rms, typical, 50 Ω)			
5 mV/div	376 μ Vrms	454 μ Vrms	502 μ Vrms
10 mV/div	376 μ Vrms	454 μ Vrms	502 μ Vrms
20 mV/div	502 μ Vrms	592 μ Vrms	624 μ Vrms
50 mV/div	1.17 mVrms	1.31 mVrms	1.36 mVrms
100 mV/div	2.32 mVrms	2.59 mVrms	2.72 mVrms
200 mV/div	4.48 mVrms	5.15 mVrms	5.54 mVrms
500 mV/div	11.06 mVrms	12.51 mVrms	12.89 mVrms
1 V/div	21.95 mVrms	--	--
Sensitivity	50 Ω (ProLink): 5 mV - 1 V/div, fully variable 50 Ω (ProBus): 2 mV - 1 V/div, fully variable 1 MΩ (ProBus): 2 mV - 10 V/div, fully variable	50 Ω (ProAxial): 5 mV - 500 mV/div, fully variable 50 Ω (ProBus): 2 mV - 1 V/div, fully variable 1 MΩ (ProBus): 2 mV - 10 V/div, fully variable	
DC Vertical Gain Accuracy (Gain Component of DC Accuracy)	$\pm 0.5\%$ F.S. (typical), offset at 0 V; $\pm 1.2\%$ F.S. (test limit), offset at 0 V with ProBus inputs; $\pm 1.5\%$ F.S. (test limit), offset at 0 V with ProLink/ProAxial inputs		
Channel-Channel Isolation	ProLink/ProAxial inputs: DC to 33 GHz: 60 dB (>1000:1) ProBus inputs: DC to 200 MHz: 70 dB (>3000:1), 200 to 500 MHz: 60 dB (>1000:1), 500 MHz to 1 GHz: 50 dB (>300:1), 1 GHz to 2 GHz: 40 dB (>100:1) (For any two input channels, same V/div settings, typical)		
Offset Range	50 Ω (ProLink/ProAxial): ± 500 mV @ 5 - 100 mV/div ± 4 V @ 102 mV/div - 500 mV/div 50 Ω (ProBus): ± 1.6 V @ 1 mV - 4.95 mV/div ± 4 V @ 5 mV - 9.9 mV/div ± 8 V @ 10 mV - 19.8 mV/div ± 10 V @ 20 mV - 1 V/div 1 MΩ (ProBus): ± 1.6 V @ 1 mV - 4.95 mV/div ± 4 V @ 5 mV - 9.9 mV/div ± 8 V @ 10 mV - 19.8 mV/div ± 16 V @ 20 mV - 100 mV/div ± 80 V @ 102 mV - 198 mV/div ± 160 V @ 200 mV - 1 V/div ± 400 V @ 1.02 V - 10 V/div		
DC Vertical Offset Accuracy	$\pm (1\%$ of offset setting + 1% F.S. + 1 mV) (test limit)		

SPECIFICATIONS

	WaveMaster/SDA 8500HD	WaveMaster/SDA 8590HD	WaveMaster/SDA 8650HD
Vertical System			
Analog Bandwidth @ 50 Ω (-3 dB) (1.85 mm Input)	50 GHz (≥ 10 mV/div)	59 GHz (≥ 10 mV/div)	65 GHz (≥ 10 mV/div)
Analog Bandwidth @ 50 Ω (-3 dB) (ProAxial Input)	33 GHz (≥ 5 mV/div)		
Analog Bandwidth @ 50 Ω (-3 dB) (ProBus Input)	2 GHz (≥ 10 mV/div)		
Analog Bandwidth @ 1 M Ω (-3 dB) (ProBus Input)	500 MHz (typical, ≥ 2 mV/div)		
Rise Time (10 - 90%, 50 Ω - typical)	8.2 ps (flatness mode)	6.8 ps (flatness mode)	6.5 ps (flatness mode)
Rise Time (20 - 80%, 50 Ω - typical)	6.2 ps (flatness mode)	5.1 ps (flatness mode)	4.9 ps (flatness mode)
Input Channels	4 (Any combination of 33 GHz ProAxial inputs or 2 GHz ProBus inputs), 3 (A combination of one 1.85mm input @ full BW and two ProLink or ProBus inputs), or 2 (1.85mm inputs @ full BW)		
Vertical Resolution	12 bits; up to 15 bits with enhanced resolution (ERES)		
Vertical Noise Floor (rms, 50 Ω)			
5 mV/div	--	--	--
10 mV/div	737 μ Vrms	801 μ Vrms	841 μ Vrms
20 mV/div	976 μ Vrms	1.06 mVrms	1.11 mVrms
50 mV/div	2.04 mVrms	2.22 mVrms	2.33 mVrms
100 mV/div	3.93 mVrms	4.27 mVrms	4.48 mVrms
200 mV/div	--	--	--
500 mV/div	--	--	--
1 V/div	--	--	--
Sensitivity	50 Ω (1.85mm): 10 mV - 100 mV/div, fully variable 50 Ω (ProAxial): 5 mV - 500 mV/div, fully variable 50 Ω (ProBus): 2 mV - 1 V/div, fully variable 1 MΩ (ProBus): 2 mV - 10 V/div, fully variable		
DC Vertical Gain Accuracy (Gain Component of DC Accuracy)	$\pm 0.5\%$ F.S. (typical), offset at 0 V; $\pm 1.2\%$ F.S. (test limit), offset at 0 V with ProBus inputs; $\pm 1.5\%$ F.S. (test limit), offset at 0 V with 1.85 mm/ProAxial inputs		
Channel-Channel Isolation	1.85 mm inputs: DC to 33 GHz: 60 dB (>1000:1) 33 to 65 GHz: 40 dB (>100:1) ProAxial inputs: DC to 33 GHz: 60 dB (>1000:1) ProBus inputs: DC to 200 MHz: 70 dB (>3000:1), 200 to 500 MHz: 60 dB (>1000:1), 500 MHz to 1 GHz: 50 dB (>300:1), 1 GHz to 2 GHz: 40 dB (>100:1)		
Offset Range	(For any two input channels, same V/div settings, typical) 50 Ω (1.85mm): ± 500 mV @ 10 - 100 mV/div 50 Ω (ProLink/ProAxial): ± 500 mV @ 5 - 100 mV/div ± 4 V @ 102 mV/div - 500mV/div 50 Ω (ProBus): ± 1.6 V @ 1 mV - 4.95 mV/div ± 4 V @ 5 mV - 9.9 mV/div ± 8 V @ 10 mV - 19.8 mV/div ± 10 V @ 20 mV - 1 V/div 1 MΩ (ProBus): ± 1.6 V @ 1 mV - 4.95 mV/div ± 4 V @ 5 mV - 9.9 mV/div ± 8 V @ 10 mV - 19.8 mV/div ± 16 V @ 20 mV - 100 mV/div ± 80 V @ 102 mV - 198 mV/div ± 160 V @ 200 mV - 1 V/div ± 400 V @ 1.02 V - 10 V/div		
DC Vertical Offset Accuracy	$\pm 1\%$ of offset setting + 1% F.S. + 1 mV (test limit)		

SPECIFICATIONS

	WaveMaster/SDA 8200HD	WaveMaster/SDA 8250HD	WaveMaster/SDA 8330HD
Vertical System			
Maximum Input Voltage	50 Ω (ProLink/ProAxial): ±2V Vmax 50 Ω (ProBus): ≤5 Vrms 1 MΩ (ProBus): 1 MΩ // 20pF ≤400 Vpeak		
Input Coupling	ProLink/ProAxial Inputs: 50 Ω: DC, GND ProBus Inputs: 1 MΩ: AC, DC, GND; 50 Ω: DC, GND		
Input Impedance	ProLink/ProAxial Inputs: 50 Ω ±2% ProBus Inputs: 50 Ω ±2% or 1 MΩ // 20 pF, 10 MΩ // 10 pF with supplied passive probe		
Bandwidth Limiters	50 Ω (ProLink/ProAxial): Fully variable from 1 GHz to instrument bandwidth in increments of 100 MHz 50 Ω (ProBus): 200 MHz, 20 MHz, Fully variable from 1 GHz to 2 GHz in increments of 100 MHz 1 MΩ (ProBus): 200 MHz, 20 MHz		
Rescaling	Length: meters, inches, feet, yards, miles; Mass: grams, slugs; Temperature: celsius, fahrenheit, kelvin; Angle: radian, arcdegr, arcmin, arcsec, cycles, revolutions, turns; Velocity: m/s, in/s, ft/s, yd/s, miles/s; Acceleration: m/s ² , in/s ² , ft/s ² , g0; Volume: liters, cubic meters, cubic inches, cubic feet, cubic yards; Force (Weight): newton, grain, ounce, pound; Pressure: pascal, bar, atmosphere (technical), atmosphere (standard), torr, psi; Electrical: volts, amps, watts, volt-amperes, volt-amperes reactive, farad, coulomb, ohm, siemen, volt/meter, coulomb/m ² , farad/meter, siemen/meter, power factor; Magnetic: weber, tesla, henry, amp/meter, henry/meter; Energy: joule, Btu, calorie; Rotating Machine: radian/second, frequency, revolution/second, revolution/minute, N·m, lb-ft, lb-in, oz-in, watt, horsepower; Other: %.		
Horizontal - Analog Channels			
Timebases	Internal timebase common to 4 input channels		
Time/Division Range	20 ps/div - 5000 s/div (maximum capture time is based on minimum sample rate of 1 kS/s and installed memory)		
Clock Accuracy	<0.1 ppm + (aging of 0.05 ppm/yr from last calibration)		
Sample Clock Jitter	up to 1 μs Acquired Time Range: 15 fsrms (Internal Timebase Reference) up to 10 μs Acquired Time Range: 28 fsrms (Internal Timebase Reference) up to 100 μs Acquired Time Range: 32 fsrms (Internal Timebase Reference) up to 1 ms Acquired Time Range: 33 fsrms (Internal Timebase Reference)		
Delta Time Measurement Accuracy	$\sqrt{2} * \sqrt{\left(\frac{\text{Noise}}{\text{SlewRate}}\right)^2 + (\text{Sample Clock Jitter})^2 \text{ (RMS)} + (\text{clock accuracy} * \text{reading}) \text{ (seconds)}}$		
Jitter Measurement Floor	$\sqrt{\left(\frac{\text{Noise}}{\text{SlewRate}}\right)^2 + (\text{Sample Clock Jitter})^2 \text{ (RMS, seconds, TIE)}}$		
Channel-Channel Deskew Range	25 ns		
External Timebase Reference (Input)	10 MHz; 50 Ω impedance, applied at the rear input		
External Timebase Reference (Output)	10 MHz; 50 Ω impedance, output at the rear		

SPECIFICATIONS

	WaveMaster/SDA 8500HD	WaveMaster/SDA 8590HD	WaveMaster/SDA 8650HD
Vertical System			
Maximum Input Voltage	50 Ω (ProAxial/1.85mm): ±2 V Vmax 50 Ω (ProBus): ≤5 Vrms 1 MΩ (ProBus): 1 MΩ 20 pF ≤400 Vpeak		
Input Coupling	ProAxial/1.85mm Inputs: 50 Ω: DC, GND ProBus Inputs: 1 MΩ: AC, DC, GND; 50 Ω: DC, GND		
Input Impedance	ProAxial/1.85mm Inputs: 50 Ω ±2% ProBus Inputs: 50 Ω ±2% or 1 MΩ 20 pF, 10 MΩ 10 pF with supplied passive probe		
Bandwidth Limiters	50 Ω (1.85mm): Fully variable from 1 GHz to instrument bandwidth in increments of 100 MHz 50 Ω (ProAxial): Fully variable from 1 GHz to 33 GHz in increments of 100 MHz 50 Ω (ProBus): 200 MHz, 20 MHz, Fully variable from 1 GHz to 2 GHz in increments of 100 MHz 1 MΩ (ProBus): 200 MHz, 20 MHz		
Rescaling	Length: meters, inches, feet, yards, miles; Mass: grams, slugs; Temperature: celsius, fahrenheit, kelvin; Angle: radian, arcdegr, arcmin, arcsec, cycles, revolutions, turns; Velocity: m/s, in/s, ft/s, yd/s, miles/s; Acceleration: m/s ² , in/s ² , ft/s ² , g0; Volume: liters, cubic meters, cubic inches, cubic feet, cubic yards; Force (Weight): newton, grain, ounce, pound; Pressure: pascal, bar, atmosphere (technical), atmosphere (standard), torr, psi; Electrical: volts, amps, watts, volt-amperes, volt-amperes reactive, farad, coulomb, ohm, siemen, volt/meter, coulomb/m ² , farad/meter, siemen/meter, power factor; Magnetic: weber, tesla, henry, amp/meter, henry/meter; Energy: joule, Btu, calorie; Rotating Machine: radian/second, frequency, revolution/second, revolution/minute, N·m, lb-ft, lb-in, oz-in, watt, horsepower; Other: %.		
Horizontal - Analog Channels			
Timebases	Internal timebase common to 4 input channels		
Time/Division Range	For >33 GHz Mode: 20 ps/div - 5 ms/div (maximum capture time is based on 320 GS/s and installed memory) For ≤33 GHz Mode: 20 ps/div - 5000 s/div (maximum capture time is based on minimum sample rate of 1 kS/s and installed memory)		
Clock Accuracy	<0.1 ppm + (aging of 0.05 ppm/yr from last calibration)		
Sample Clock Jitter	up to 1 μs Acquired Time Range: 15 fsrms (Internal Timebase Reference) up to 10 μs Acquired Time Range: 28 fsrms (Internal Timebase Reference) up to 100 μs Acquired Time Range: 32 fsrms (Internal Timebase Reference) up to 1 ms Acquired Time Range: 33 fsrms (Internal Timebase Reference)		
Delta Time Measurement Accuracy	$\sqrt{2} * \sqrt{\left(\frac{\text{Noise}}{\text{SlewRate}}\right)^2 + (\text{Sample Clock Jitter})^2 \text{ (RMS)} + (\text{clock accuracy} * \text{reading}) \text{ (seconds)}}$		
Jitter Measurement Floor	$\sqrt{\left(\frac{\text{Noise}}{\text{SlewRate}}\right)^2 + (\text{Sample Clock Jitter})^2 \text{ (RMS, seconds, TIE)}}$		
Channel-Channel Deskew Range	25 ns		
External Timebase Reference (Input)	10 MHz; 50 Ω impedance, applied at the rear input		
External Timebase Reference (Output)	10 MHz; 50 Ω impedance, output at the rear		

SPECIFICATIONS

WaveMaster/SDA 8200HD

WaveMaster/SDA 8250HD

WaveMaster/SDA 8330HD

Acquisition - Analog Channels

Sample Rate (Single-Shot)	160 GS/s on 4 Ch with Enhanced Sample Rate
Memory Length (4 Ch)	Standard: 200 Mpts 500MPT option (standard in SDA models): 500 Mpts 2000MPT option: 2000 Mpts 8000MPT option: 8000 Mpts
Number of Segments in Sequence	65,535
Acquisition Mode	
Intersegment Time	1.1 μ s
Averaging	Summed averaging to 1 million sweeps; continuous averaging to 1 million sweeps
Interpolation	Linear or Sin(x)/x

Vertical, Horizontal, Acquisition - Digital Channels

	WM8KHD-MSO option	HDA125-18-LBUS
Maximum Input Frequency	500 MHz	3 GHz
Minimum Detectable Pulse Width	1 ns ± 20 V	167 ps
Input Dynamic Range		± 10 V on any single-ended input ± 7.5 V max differential
Input Impedance (Flying Leads)	100 k Ω 5 pF	QL-SI tips: 110 k Ω , 0.12 pF differential
Input Channels	16 Digital Channels ± 30 V Peak	18 Digital Channels ± 15 V on any single-ended input ± 15 V max differential
Maximum Input Voltage		
Minimum Input Voltage Swing	400 mV	150 mV p-p
Threshold Selections	TTL, ECL, CMOS (2.5 V, 3.3 V, 5 V), PECL, LVDS or User Defined	User Defined
Threshold Accuracy	$\pm(3\%$ of threshold setting + 100 mV)	$\pm(25$ mV + 3% of threshold setting)
User-Defined Threshold Range	± 10 V in 20 mV steps	± 5 V, settable per channel in 5 mV steps
User-Defined Hysteresis Range	100 mV to 1.4 V in 100 mV steps	50 mV to 600 mV settable per channel
Sample Rate	2.5 GS/s	12.5 GS/s
Channel-to-Channel Skew	350 ps	± 160 ps

SPECIFICATIONS

WaveMaster/SDA 8500HD

WaveMaster/SDA 8590HD

WaveMaster/SDA 8650HD

Acquisition - Analog Channels

Sample Rate (Single-Shot)	1.85mm inputs: 320 GS/s on 2 Ch with Enhanced Sample Rate; ProAxial/ProBus inputs: 160 GS/s on 4 Ch with Enhanced Sample Rate
Memory Length 1.85 mm / ProAxial	Standard: 400 Mpts / 200 Mpts 500MPT option (standard in SDA models): 1000 Mpts / 500 Mpts 2000MPT option: 4000 Mpts / 2000 Mpts 8000MPT option: 16000 Mpts / 8000 Mpts
Number of Segments in Sequence	65,535
Acquisition Mode	
Intersegment Time	1.1 μ s
Averaging	Summed averaging to 1 million sweeps; continuous averaging to 1 million sweeps
Interpolation	Linear or Sin(x)/x

Vertical, Horizontal, Acquisition - Digital Channels

	WM8KHD-MSO option	HDA125-18-LBUS
Maximum Input Frequency	500 MHz	3 GHz
Minimum Detectable Pulse Width	1 ns ± 20 V	167 ps
Input Dynamic Range		± 10 V on any single-ended input ± 7.5 V max differential
Input Impedance (Flying Leads)	100 k Ω 5 pF	QL-SI tips: 110 k Ω , 0.12 pF differential
Input Channels	16 Digital Channels ± 30 V Peak	18 Digital Channels ± 15 V on any single-ended input ± 15 V max differential
Maximum Input Voltage		± 15 V max differential
Minimum Input Voltage Swing	400 mV	150 mV p-p
Threshold Selections	TTL, ECL, CMOS (2.5 V, 3.3 V, 5 V), PECL, LVDS or User Defined	User Defined
Threshold Accuracy	$\pm(3\%$ of threshold setting + 100 mV)	$\pm(25$ mV + 3% of threshold setting)
User-Defined Threshold Range	± 10 V in 20 mV steps	± 5 V, settable per channel in 5 mV steps
User-Defined Hysteresis Range	100 mV to 1.4 V in 100 mV steps	50 mV to 600 mV settable per channel
Sample Rate	2.5 GS/s	12.5 GS/s
Channel-to-Channel Skew	350 ps	± 160 ps

SPECIFICATIONS

WaveMaster/SDA 8200HD

WaveMaster/SDA 8250HD

WaveMaster/SDA 8330HD

Triggering System

Modes	Acquisition of ≤500 Mpts: Normal, Auto, Single, and Stop Acquisition of >500 Mpts: Single
Sources	Any input channel, Aux, Aux/10, Line, or Fast Edge. Slope and level unique to each source (except line trigger).
Coupling	DC, AC, HFRej, LFRRej
Pre-trigger Delay	0 - 100% of memory size (adjustable in 1% increments of 100 ns)
Post-trigger Delay	0 - 10,000 divisions in real-time mode, limited at slower time/div settings
Hold-off	From 2 ns up to 20 s or from 1 to 99,999,999 events
Trigger and Interpolator Jitter	<0.1 ps rms (typical, software assisted), 2 ps rms (typical, hardware)
Internal Trigger Level Range	±3 div from center (typical)
External Trigger Level Range	Aux (±0.4 V); Aux/10 (±4 V)
Maximum Trigger Rate	>900,000 waveforms/second (in Sequence Mode, up to 4 channels)
Trigger Sensitivity with Edge Trigger	3 div @ <12 GHz
ProAxial/ProLink inputs	1.5 div @ <3 GHz 1.0 div @ <200 MHz (for DC coupling, ≥10 mV/div, 50 Ω)
Trigger Sensitivity with Edge Trigger	2.5 div @ <1 GHz
ProBus Inputs	2 div @ <1 GHz 1.5 div @ <500 MHz 1 div @ <200 MHz 0.9 div @ <10 MHz (DC, AC, and LFRRej coupling, ≥2 mV/div, 50 Ω)
External Trigger Sensitivity, (Edge Trigger)	3 div @ <2 GHz 2.5 div @ <1 GHz 1.5 div @ <500 MHz 1 div @ <200 MHz 0.9 div @ <10 MHz (DC, AC, and LFRRej coupling)
Max. Trigger Frequency, SMART Trigger	2.0 GHz @ ≥10 mV/div (minimum triggerable width 200 ps)

Trigger Types

Edge	Triggers when signal meets slope (positive, negative, or either) and level condition.
Width	Triggers on positive, negative or both (widths selectable as low as 200 ps to 20 s) or on intermittent faults.
Glitch	Triggers on positive or negative glitches (widths selectable as low as 200 ps to 20 s) or on intermittent faults.
Window	Triggers when signal exits a window defined by adjustable thresholds.
Pattern	Logic combination (AND, NAND, OR, NOR) of 5 inputs (4 channels and external trigger input). Each source can be high, low or don't care. The high and low level can be selected independently. Triggers at start or end of the pattern.
Runt	Trigger on positive or negative runts defined by two voltage limits and two time limits. Select between 1 ns and 20 ns.
Slew Rate	Trigger on edge rates. Select limits for dV, dt and slope. Select edge limits between 1 ns and 20 ns.
Interval	Triggers on intervals selectable between 1 ns and 20 s.
Dropout	Triggers if signal drops out for longer than selected time between 1 ns and 20 s.
Exclusion Triggering	Trigger on intermittent faults by specifying the expected behavior and triggering when that condition is not met.
Measurement Trigger	Select from a large number of measurement parameters trigger on a measurement value with qualified limits. Can be used as only trigger or last event in a Cascade Trigger.
Multi-Stage: Qualified	Triggers on any input source only if a defined state or edge occurred on another input source. Holdoff between sources is selectable by time or events.
Multi-Stage: Qualified First	In Sequence acquisition mode, triggers repeatably on event B only if a defined pattern, state or edge (event A) is satisfied in the first segment of the acquisition. Holdoff between sources is selectable by time or events.

High and Low Speed Serial Protocol Triggering (Optional)

Please refer to the *Oscilloscope Features, Options, and Accessories Catalog* for the latest offerings on all our instruments

Measurement Tools

Measurement Functionality	Display up to 12 measurement parameters together with statistics including mean, minimum, maximum, standard deviation, and total number. Each occurrence of each parameter is measured and added to the statistics table. Histograms provide a fast, dynamic view of parameters and waveshape characteristics. Parameter math allows addition, subtraction, multiplication or division of two different parameters. Parameter gates define the location for measurement on the source waveform. Parameter accept criteria define allowable values based on range setting or waveform state.
Measurement Parameters - Horizontal + Jitter	Cycles (number of), Cycle to Cycle, Delay (from trigger, 50%), Δ Delay (50%), Duty Cycle (50%, @level), Edges (number of, @level), Fall Time (90-10, @levels), Frequency (50%, @level), Half Period (@level), Hold Time (@level), N Cycle Jitter (peak-peak), Number of Points, Period (50%, @level), Δ Period (@level), Phase (@level), Rise Time (10-90, @levels), Setup (@levels), Skew (@levels), Slew Rate (@levels), Time Interval Error (@level), Time (@level), Δ Time (@level), Width (50%, @level), Δ Width (@level), X(value)@max, X(value)@min
Measurement Parameters - Vertical	Amplitude, Base, Level@X, Maximum, Mean, Median, Minimum, Peak-to-Peak, RMS, Std. Deviation, Top
Measurement Parameters - Pulse	Area, Base, Fall Time (90-10, 80-20, @levels), Overshoot (positive, negative), Rise Time (10-90, 80-20, @levels), Top, Width (50%)
Measurement Parameters - Statistical (on Histograms)	Full Width (@ Half Max, @%), Amplitude, Base, Peak@MaxPopulation, Maximum, Mean, Median, Minimum, Mode, Range, RMS, Std. Deviation, Top, X(value)@Peak, Peaks (number of), Percentile, Population (@bin, total)

SPECIFICATIONS

WaveMaster/SDA 8500HD

WaveMaster/SDA 8590HD

WaveMaster/SDA 8650HD

Triggering System

Modes	Acquisition of ≤500 Mpts: Normal, Auto, Single, and Stop Acquisition of >500 Mpts: Single
Sources	Any input channel, Aux, Aux/10, Line, or Fast Edge. Slope and level unique to each source (except line trigger).
Coupling	DC, AC, HFRej, LFRRej
Pre-trigger Delay	0 - 100% of memory size (adjustable in 1% increments of 100 ns)
Post-trigger Delay	0 - 10,000 divisions in real-time mode, limited at slower time/div settings
Hold-off	From 2 ns up to 20 s or from 1 to 99,999,999 events
Trigger and Interpolator Jitter	<0.1 ps rms (typical, software assisted), 2 ps rms (typical, hardware)
Internal Trigger Level Range	±3 div from center (typical)
External Trigger Level Range	Aux (±0.4 V); Aux/10 (±4 V)
Maximum Trigger Rate	> 900,000 waveforms/second (in Sequence Mode, up to 4 channels)
Trigger Sensitivity with Edge Trigger 1.85 mm/ProAxial Inputs	3 div @ <12 GHz 1.5 div @ <3 GHz 1.0 div @ <200 MHz (for DC coupling, ≥10 mV/div, 50 Ω)
Trigger Sensitivity with Edge Trigger ProBus Inputs	2.5 div @ <1 GHz 2 div @ <1 GHz 1.5 div @ <500 MHz 1 div @ <200 MHz 0.9 div @ <10 MHz (DC, AC, and LFRRej coupling, ≥2 mV/div, 50 Ω)
External Trigger Sensitivity, (Edge Trigger)	3 div @ <2 GHz 2.5 div @ <1 GHz 1.5 div @ <500 MHz 1 div @ <200 MHz 0.9 div @ <10 MHz (DC, AC, and LFRRej coupling)
Max. Trigger Frequency, SMART Trigger	2.0 GHz @ ≥10 mV/div (minimum triggerable width 200 ps)

Trigger Types

Edge	Triggers when signal meets slope (positive, negative or either) and level condition.
Width	Triggers on positive, negative or both widths (widths selectable as low as 200 ps to 20 s) or on intermittent faults.
Glitch	Triggers on positive or negative glitches (widths selectable as low as 200 ps to 20 s) or on intermittent faults.
Window	Triggers when signal exits a window defined by adjustable thresholds.
Pattern	Logic combination (AND, NAND, OR, NOR) of 5 inputs (4 channels and external trigger input). Each source can be high, low or don't care. The high and low level can be selected independently. Triggers at start or end of the pattern.
Runt	Trigger on positive or negative runts defined by two voltage limits and two time limits. Select between 1 ns and 20 ns.
Slew Rate	Trigger on edge rates. Select limits for dV, dt and slope. Select edge limits between 1 ns and 20 ns.
Interval	Triggers on intervals selectable between 1 ns and 20 s.
Dropout	Triggers if signal drops out for longer than selected time between 1 ns and 20 s.
Exclusion Triggering	Trigger on intermittent faults by specifying the expected behavior and triggering when that condition is not met.
Measurement Trigger	Select from a large number of measurement parameters, trigger on a measurement value with qualified limits. Can be used as only trigger or last event in a Cascade Trigger.
Multi-Stage: Qualified	Triggers on any input source only if a defined state or edge occurred on another input source. Holdoff between sources is selectable by time or events.
Multi-Stage: Qualified First	In Sequence acquisition mode, triggers repeatably on event B only if a defined pattern, state or edge (event A) is satisfied in the first segment of the acquisition. Holdoff between sources is selectable by time or events.

High- and Low-speed Serial Protocol Triggering (Optional)

Please refer to the *Oscilloscope Features, Options and Accessories Catalog* for the latest offerings on all our instruments.

Measurement Tools

Measurement Functionality	Display up to 12 measurement parameters together with statistics including mean, minimum, maximum, standard deviation and total number. Each occurrence of each parameter is measured and added to the statistics table. Histicons provide a fast, dynamic view of parameters and waveshape characteristics. Parameter math allows addition, subtraction, multiplication or division of two different parameters. Parameter gates define the location for measurement on the source waveform. Parameter accept criteria define allowable values based on range setting or waveform state.
Measurement Parameters - Horizontal + Jitter	Cycles (number of), Cycle to Cycle, Delay (from trigger, 50%), Δ Delay (50%), Duty Cycle (50%, @level), Edges (number of, @level), Fall Time (90-10, @levels), Frequency (50%, @level), Half Period (@level), Hold Time (@level), N Cycle Jitter (peak-peak), Number of Points, Period (50%, @level), Δ Period (@level), Phase (@level), Rise Time (10-90, @levels), Setup (@levels), Skew (@levels), Slew Rate (@levels), Time Interval Error (@level), Time (@level), Δ Time (@level), Width (50%, @level), Δ Width (@level), X(value)@max, X(value)@min
Measurement Parameters - Vertical	Amplitude, Base, Level@X, Maximum, Mean, Median, Minimum, Peak-to-Peak, RMS, Std. Deviation, Top
Measurement Parameters - Pulse	Area, Base, Fall Time (90-10, 80-20, @levels), Overshoot (positive, negative), Rise Time (10-90, 80-20, @levels), Top, Width (50%)
Measurement Parameters - Statistical (on Histograms)	Full Width (@ Half Max, @%), Amplitude, Base, Peak@MaxPopulation, Maximum, Mean, Median, Minimum, Mode, Range, RMS, Std. Deviation, Top, X(value)@Peak, Peaks (number of), Percentile, Population (@bin, total)

SPECIFICATIONS

	WaveMaster/SDA 8200HD	WaveMaster/SDA 8250HD	WaveMaster/SDA 8330HD
Math Tools			
Math Functionality	Display up to 12 math functions traces (F1-F12). The easy-to-use graphical interface simplifies set up of up to two operations on each function trace, and function traces can be chained together to perform math-on-math.		
Math Operators - Basic Math	Average (summed), Average (continuous), Difference (-), Envelope, Floor, Invert (negate), Product (x), Ratio (/), Reciprocal, Rescale (with units), Roof, Sum (+)		
Math Operators - Digital (incl. with MSO options)	Digital AND, Digital DFlipFlop, Digital NAND, Digital NOR, Digital NOT, Digital OR, Digital XOR		
Math Operators - Filters	Enhanced resolution (to 15 bits vertical), Interpolate (cubic, quadratic, sinx/x)		
Math Operators - Frequency Analysis	FFT (power spectrum, magnitude, phase, power density, real, imaginary, magnitude squared) up to full analysis memory length. Select from Rectangular, VonHann, Hamming, FlatTop and Blackman Harris windows.		
Math Operators - Functions	Absolute value, Correlation (two waveforms), Derivative, Deskew (resample), Exp (base e), Exp (base 10), Integral, Invert (negate), Log (base e), Log (base 10), Reciprocal, Rescale (with units), Square, Square root, Zoom (identity)		
Math Operators - Other	Segment, Sparse		
Measurement and Math Integration			
	Histograms to display statistical distributions of up to 2 billion measurement parameters. Trend (datalog) of up to 1 million measurement parameters. Track (display parameter vs. time, time-correlated to acquisitions) any parameter. Persistence histogram and persistence trace (mean, range, sigma).		
Pass/Fail Testing			
	Display up to 12 Pass/Fail queries using a Single or Dual Parameter Comparison (compare All values, or Any value <, ≤, =, >, ≥, within limit ±Δ value or %) or Mask Test (pre-defined or user-defined mask, waveform All In, All Out, Any In, or Any Out conditions). Combine queries into a boolean expression to Pass or Fail IF "All True", "All False", "Any True", "Any False", or groups of "All" or "Any", with following THEN Save (waveforms), Stop, Alarm, (send) Pulse, Hardcopy (send email, save screen image, save to clipboard, send to printer), or (save) LabNotebook.		
Display System			
Size	Color 15.6" widescreen capacitive touch screen		
Resolution	1920 x 1080 pixels		
Number of Traces	Display a maximum of 40 traces. Simultaneously display channel, zoom, memory and math traces.		
Grid Styles	Auto, Single, Dual, Quad, Octal, X-Y, Single+X-Y, Dual+X-Y, Tandem, Quatro, Twelve, Sixteen		
Waveform Representation	Sample dots joined, or sample dots only		
Processor/CPU			
Type	Intel Core i7-12700E or better		
System RAM	64 GB		
Operating System	Microsoft Windows® 10		
Real-Time Clock	Date and time displayed with waveform in hardcopy files. SNTP support to synchronize to precision internal clocks.		
Connectivity			
Ethernet Port	Supports 2.5GBaseT Ethernet interface (RJ45 port)		
USB Host Ports	4 side USB 3.2 Gen2x1 Type-A ports, 2 front panel USB 3.2 Gen1x1 Type-A ports, 1 front panel USB 3.2 Gen1x1 Type-C port support Windows compatible devices		
USB Device Port	1 port - USBTMC over USB 3.1 Gen1		
GPIB Port (Optional)	Supports IEEE-488.2 (external)		
External Monitor Port	2 x HDMI, supports up to 4096 x 2304 resolution 1 x DisplayPort, supports up to 4096 x 2304 resolution		
Remote Control	Via Microsoft COM Automation, or via LeCroy Remote Command Set		
Network Communication Standard	VXI-11 or VICP, LXI Class C (v1.2) compliant		
Power Requirements			
Voltage	90 to 264 Vrms, 47 to 63 Hz		
Nominal Power Consumption	1125 W / 1125 VA		
Max Power Consumption	1250 W / 1250 VA		
Environmental			
Temperature (Operating)	+5 °C to +40 °C		
Temperature (Non-Operating)	-20 °C to +60 °C		
Humidity (Operating)	5% to 90% RH (non-condensing) up to +31 °C, upper limit derating to 50% RH (non-condensing) at +40 °C		
Humidity (Non-Operating)	5% to 95% RH (non-condensing) as tested per MIL-PRF-28800F		
Altitude (Operating)	Up to 10,000 ft (3048 m) at or below +30 °C		
Altitude (Non-Operating)	Up to 40,000 ft (12,192 m)		
Random Vibration (Operating)	0.5 grms 5 Hz to 500 Hz, 15 minutes in each of three orthogonal axes		
Random Vibration (Non-Operating)	2.4 grms 5 Hz to 500 Hz, 15 minutes in each of three orthogonal axes		
Functional Shock	20 g peak, half sine, 11 ms pulse, 3 shocks (positive and negative) in each of three orthogonal axes, 18 shocks total		
Size and Weight			
Dimensions (HWD)	With handles and protective cover: 15" H x 20.75" W x 16.2" D (381 x 527 x 410 mm) Without handles and protective cover: 15" H x 17.5" W x 15.8" D (381 x 445 x 400 mm)		
Weight	48 lbs (21.8 kg)		
Certifications			
CE marked for the European Union	Conforms to EN 61326-1 (for EMC); EN 61010-1, EN 61010-2-030 (for Safety); EN 63000 (for RoHS)		
UL approved for the USA and Canada	Conforms to UL 61010-1 (3rd Edition), UL 61010-2-030 (2nd Edition) and CSA C22.2 No.61010-1-12		
UKCA marked for Great Britain	Conforms to UK SI 2016 No. 1091 (for EMC), UK SI 2016 No. 1101 (for Safety) and UK SI 2012 No. 3032 (for RoHS)		
Warranty and Service			
	3-year warranty; calibration recommended annually. Optional service programs include extended warranty, upgrades and calibration services.		

SPECIFICATIONS

	WaveMaster/SDA 8500HD	WaveMaster/SDA 8590HD	WaveMaster/SDA 8650HD
Math Tools			
Math Functionality	Display up to 12 math functions traces (F1-F12). The easy-to-use graphical interface simplifies set up of up to two operations on each function trace, and function traces can be chained together to perform math-on-math.		
Math Operators - Basic Math	Average (summed), Average (continuous), Difference (-), Envelope, Floor, Invert (negate), Product (x), Ratio (/), Reciprocal, Rescale (with units), Roof, Sum (+)		
Math Operators - Digital (incl. with MSO options)	Digital AND, Digital DFlipFlop, Digital NAND, Digital NOR, Digital NOT, Digital OR, Digital XOR		
Math Operators - Filters	Enhanced resolution (to 15 bits vertical), Interpolate (cubic, quadratic, sinx/x)		
Math Operators - Frequency Analysis	FFT (power spectrum, magnitude, phase, power density, real, imaginary, magnitude squared) up to full analysis memory length. Select from Rectangular, VonHann, Hamming, FlatTop and Blackman Harris windows.		
Math Operators - Functions	Absolute value, Correlation (two waveforms), Derivative, Deskew (resample), Exp (base e), Exp (base 10), Integral, Invert (negate), Log (base e), Log (base 10), Reciprocal, Rescale (with units), Square, Square root, Zoom (identity)		
Math Operators - Other	Segment, Sparse		
Measurement and Math Integration			
	Histograms to display statistical distributions of up to 2 billion measurement parameters. Trend (datalog) of up to 1 million measurement parameters. Track (display parameter vs. time, time-correlated to acquisitions) any parameter. Persistence histogram and persistence trace (mean, range, sigma).		
Pass/Fail Testing			
	Display up to 12 Pass/Fail queries using a Single or Dual Parameter Comparison (compare All values, or Any value <, ≤, =, >, ≥, within limit ±Δ value or %) or Mask Test (pre-defined or user-defined mask, waveform All In, All Out, Any In, or Any Out conditions). Combine queries into a boolean expression to Pass or Fail IF "All True", "All False", "Any True", "Any False", or groups of "All" or "Any", with following THEN Save (waveforms), Stop, Alarm, (send) Pulse, Hardcopy (send email, save screen image, save to clipboard, send to printer) or (save) LabNotebook.		
Display System			
Size	Color 15.6" widescreen capacitive touch screen		
Resolution	1920 x 1080 pixels		
Number of Traces	Display a maximum of 40 traces. Simultaneously display channel, zoom, memory and math traces.		
Grid Styles	Auto, Single, Dual, Quad, Octal, X-Y, Single+X-Y, Dual+X-Y, Tandem, Quatro, Twelve, Sixteen		
Waveform Representation	Sample dots joined, or sample dots only		
Processor/CPU			
Type	Intel Core i7-12700E or better		
System RAM	64 GB		
Operating System	Microsoft Windows® 10		
Real-Time Clock	Date and time displayed with waveform in hardcopy files. SNTP support to synchronize to precision internal clocks.		
Connectivity			
Ethernet Port	Supports 2.5GBaseT Ethernet interface (RJ45 port)		
USB Host Ports	4 side USB 3.2 Gen2x1 Type-A ports, 2 front panel USB 3.2 Gen1x1 Type-A ports, 1 front panel USB 3.2 Gen1x1 Type-C port support Windows compatible devices		
USB Device Port	1 port - USBTMC over USB 3.1 Gen1		
GPIB Port (Optional)	Supports IEEE-488.2 (external)		
External Monitor Port	2 x HDMI, supports up to 4096 x 2304 resolution 1 x DisplayPort, supports up to 4096 x 2304 resolution		
Remote Control	Via Microsoft COM Automation, or via LeCroy Remote Command Set		
Network Communication Standard	VXI-11 or VICP, LXI Class C (v1.2) compliant		
Power Requirements			
Voltage	90 to 264 Vrms, 47 to 63 Hz		
Nominal Power Consumption	1175 W / 1175 VA		
Max Power Consumption	1300 W / 1300 VA		
Environmental			
Temperature (Operating)	+5 °C to +40 °C		
Temperature (Non-Operating)	-20 °C to +60 °C		
Humidity (Operating)	5% to 90% RH (non-condensing) up to +31 °C, upper limit derating to 50% RH (non-condensing) at +40 °C		
Humidity (Non-Operating)	5% to 95% RH (non-condensing) as tested per MIL-PRF-28800F		
Altitude (Operating)	Up to 10,000 ft (3048 m) at or below +30 °C		
Altitude (Non-Operating)	Up to 40,000 ft (12,192 m)		
Random Vibration (Operating)	0.5 grms 5 Hz to 500 Hz, 15 minutes in each of three orthogonal axes		
Random Vibration (Non-Operating)	2.4 grms 5 Hz to 500 Hz, 15 minutes in each of three orthogonal axes		
Functional Shock	20 g peak, half sine, 11 ms pulse, 3 shocks (positive and negative) in each of three orthogonal axes, 18 shocks total		
Size and Weight			
Dimensions (HWD)	With handles and protective cover: 15" H x 20.75" W x 16.2" D (381 x 527 x 410 mm) Without handles and protective cover: 15" H x 17.5" W x 15.8" D (381 x 445 x 400 mm)		
Weight	53 lbs (24.0 kg)		
Certifications			
CE marked for the European Union	Conforms to EN 61326-1 (for EMC); EN 61010-1, EN 61010-2-030 (for Safety); EN 63000 (for RoHS)		
UL approved for the USA and Canada	Conforms to UL 61010-1 (3rd Edition), UL 61010-2-030 (2nd Edition) and CSA C22.2 No.61010-1-12		
UKCA marked for Great Britain	Conforms to UK SI 2016 No. 1091 (for EMC), UK SI 2016 No. 1101 (for Safety) and UK SI 2012 No. 3032 (for RoHS)		
Warranty and Service			
	3-year warranty; calibration recommended annually. Optional service programs include extended warranty, upgrades and calibration services.		

ORDERING INFORMATION

Product Description Product Code

WaveMaster 8000HD Oscilloscopes

65 GHz, 12 bits, 320 GS/s, 400 Mpts/Ch High Definition Oscilloscope	WaveMaster 8650HD
Also operates in 33 GHz 160 GS/s with 200 Mpts/Ch	
59 GHz, 12 bits, 320 GS/s, 400 Mpts/Ch High Definition Oscilloscope	WaveMaster 8590HD
Also operates in 33 GHz 160 GS/s with 200 Mpts/Ch	
50 GHz, 12 bits, 320 GS/s, 400 Mpts/Ch High Definition Oscilloscope	WaveMaster 8500HD
Also operates in 33 GHz 160 GS/s with 200 Mpts/Ch	
33 GHz, 12 bits, 160 GS/s, 200 Mpts/Ch High Definition Oscilloscope	WaveMaster 8330HD
25 GHz, 12 bits, 160 GS/s, 200 Mpts/Ch High Definition Oscilloscope	WaveMaster 8250HD
20 GHz, 12 bits, 160 GS/s, 200 Mpts/Ch High Definition Oscilloscope	WaveMaster 8200HD

SDA 8000HD Serial Data Analyzers

65 GHz, 12 bits, 320 GS/s, 1000 Mpts/Ch High Definition Serial Data Analyzer, 8 Gbps serial trigger. Also operates in 33 GHz 160 GS/s 4Ch mode with 500 Mpts/Ch	SDA 8650HD
59 GHz, 12 bits, 320 GS/s, 1000 Mpts/Ch High Definition Serial Data Analyzer, 8 Gbps serial trigger. Also operates in 33 GHz 160 GS/s 4Ch mode with 500 Mpts/Ch	SDA 8590HD
50 GHz, 12 bits, 320 GS/s, 1000 Mpts/Ch High Definition Serial Data Analyzer, 8 Gbps serial trigger. Also operates in 33 GHz 160 GS/s 4Ch mode with 500 Mpts/Ch	SDA 8500HD
33 GHz, 12 bits, 160 GS/s, 500 Mpts/Ch High Definition Serial Data Analyzer, 8 Gbps serial trigger	SDA 8330HD
25 GHz, 12 bits, 160 GS/s, 500 Mpts/Ch High Definition Serial Data Analyzer, 8 Gbps serial trigger	SDA 8250HD
20 GHz, 12 bits, 160 GS/s, 500 Mpts/Ch High Definition Serial Data Analyzer, 8 Gbps serial trigger	SDA 8200HD

Included with Standard Configuration

ProAxial - 2.92 mm adapters, Qty. 4: for ≥ 25 GHz models	
ProLink to K/2.92 mm Adapter, Qty 4: for 20 GHz units	
1.85 mm adapters (Qty.2), Universal Wrench, Torque Wrench: for ≥ 50 GHz models	
-10, 500 MHz Passive Probe (Qty. 4)	
Optical 3-button Wheel Mouse	
Protective Front Cover	
Printed Getting Started Guide	
Anti-virus Software (Trial Version)	
Microsoft Windows® 10 License	
Commercial NIST Traceable Calibration with Certificate	
Power Cable for the Destination Country	
3-year Warranty	

Mixed Signal Solutions

2.5 GS/s Internal Mixed Signal Option for WaveMaster/ SDA 8000HD (includes probe, accessories, and license)	WM8KHD-MSO
12.5 GS/s High-speed Digital Analyzer with 18ch Quick- Link leadset and LBUS connection	HDA125-18-LBUS
12.5 GS/s High-speed Digital Analyzer with 9ch QuickLink leadset and LBUS connection	HDA125-09-LBUS

Memory and Sample Rate Options

500 Mpt memory option for WaveMaster 8000HD (standard on SDA 8000HD)	WM8KHD-500MPT
2 Gpt memory option for WaveMaster 8000HD	WM8KHD-2000MPT
8 Gpt memory option for WaveMaster 8000HD	WM8KHD-8000MPT
2 Gpt memory option for SDA 8000HD	SDA8KHD-2000MPT
8 Gpt memory option for SDA 8000HD	SDA8KHD-8000MPT

CPU, Computer and Other Hardware Options

Additional Removable Solid State Drive for WaveMaster/SDA 8000HD	WM8KHD-RSSD-02
---	----------------

Cross-layer Analysis Software

PCIe CrossSync PHY protocol analyzer synchronization for WaveMaster/SDA 8000HD	WM8KHD-CROSSSYNC-PHY-PCIE
USB CrossSync PHY protocol analyzer synchronization for WaveMaster/SDA 8000HD	WM8KHD-CROSSSYNC-PHY-USB

Product Description Product Code

Serial Data and CrossTalk Analysis

SDA Expert single lane eye, noise and jitter analysis for NRZ signals	WM8KHD-SDAX-NRZ
SDA Expert single lane eye, noise and jitter analysis for PAM3 and PAM4 signals	WM8KHD-SDAX-PAM
SDA Expert multilane eye, noise and jitter analysis for NRZ, PAM3, PAM4 signals. Includes integrated EyeDrill and VirtualProbe toolkits	WM8KHD-SDAX-COMPLETE
SDA Expert Complete upgrade for SDA8000HD	SDA8KHD-SDAX-COMPLETE
SDA Expert configuration and measurements for NRZ PCI Express signals up to 32 GT/s	WM8KHD-SDAX-PCIE-NRZ
SDA Expert configuration and measurements for PAM4 PCI Express signals up to 64 GT/s	WM8KHD-SDAX-PCIE6
SDA Expert configuration and measurements for USB3.2 signals at 5 Gb/s and 10 Gb/s	WM8KHD-SDAX-USB3.2
SDA Expert configuration and measurements for USB4 NRZ signals at 10 Gb/s and 20 Gb/s, and PAM3 signals at 40 Gb/s	WM8KHD-SDAX-USB4-TB†
SDA Expert configuration and measurements for DisplayPort 1.4 and DP2 signals	WM8KHD-SDAX-DP

Signal Integrity Toolkits

Advanced De-embedding, Emulation and Virtual Probing Toolkit	WM8KHD-VIRTUALPROBE
Signal Integrity Toolkit - Channel & Fixture De-embedding/Emulation, Tx/Rx Equalization	WM8KHD-EYEDRII
Cable De-embedding Option	WM8KHD-CBL-DE-EMBED

Modulated Signal Analysis

VectorLinQ – Flexible vector signal analysis for electrical signals (RF and baseband I-Q)	WM8KHD-VECTORLINQ
VectorLinQ – Advanced vector signal analysis, includes OFDM	WM8KHD-VECTORLINQ-ADV

Ethernet and DDR Debug Toolkits

100Base-T1 and 1000Base-T1 Debug Toolkit	WM8KHD-AUTO-ENET-TOOLKIT
DDR2 and LPDDR2 Debug Toolkit	WM8KHD-DDR2-TOOLKIT
DDR 2/3 and LPDDR 2/3 Debug Toolkit	WM8KHD-DDR3-TOOLKIT
DDR 2/3/4 and LPDDR 2/3/4/4X Debug Toolkit	WM8KHD-DDR4-TOOLKIT
DDR 2/3/4/5 and LPDDR 2/3/4/4X Debug Toolkit	WM8KHD-DDR5-TOOLKIT

Serial Data Compliance Test Software

QualiPHY Enabled 1000Base-T1 (Automotive Ethernet) Software Option	QPHY-1000BASE-T1
QualiPHY Enabled 100Base-T1 (Automotive Ethernet) Software Option	QPHY-100BASE-T1
QualiPHY Enabled 10Base-T1L (Industrial Ethernet) Compliance Software Option	QPHY-10Base-T1L
QualiPHY Enabled 10Base-T1S (Automotive Ethernet) Software Option	QPHY-10BASE-T1S
QualiPHY Enabled 10GBase-KR Software Option	QPHY-10GBASE-KR
QualiPHY Enabled 10GBase-T Software Option	QPHY-10GBASE-T
QualiPHY Enabled DDR2 Software Option	QPHY-DDR2
QualiPHY Enabled DDR3, DDR3L and LPDDR3 Software Option	QPHY-DDR3
QualiPHY Enabled DDR4 and LPDDR4/4X Software Option	QPHY-DDR4
QualiPHY Enabled DisplayPort 1.4 Source Software Option	QPHY-DP14-SOURCE
QualiPHY Enabled DisplayPort 2.0 Sink Compliance Software Option	QPHY-DP20-SINK
QualiPHY Enabled DisplayPort 2.0 Source Compliance Software Option (Includes QPHY-DP14-SOURCE)	QPHY-DP20-SOURCE
QualiPHY Enabled Embedded DisplayPort Software Option	QPHY-eDP
QualiPHY Enabled Ethernet 10/100/1000BT Software Option	QPHY-ENET*
QualiPHY Enabled HDMI 2.0/1.4b TMDS Software Option	QPHY-HDMI2
QualiPHY Enabled HDMI 2.1 FRL and TMDS Software Option	QPHY-HDMI21
QualiPHY Enabled MIPI C-PHY Software Option	QPHY-MIPI-CPHY
QualiPHY Enabled MIPI D-PHY Software Option	QPHY-MIPI-DPHY
QualiPHY Enabled MIPI M-PHY Software Option	QPHY-MIPI-MPHY
QualiPHY Enabled MultiGBase-T1 (Automotive Ethernet) Compliance Software Option	QPHY-MultiGBase-T1
QualiPHY Enabled PCIe 1.0/2.0 Software Option	QPHY-PCIE
QualiPHY Enabled PCIe 3.0 Tx/Rx Software Option	QPHY-PCIE3-TX-RX
QualiPHY PCIe 4.0 Compliance Software Option	QPHY-PCIE4-TX-RX
QualiPHY PCIe 5.0 Compliance Software Option	QPHY-PCIE5-TX-RX
QualiPHY PCIe 6.0 Compliance Software Option	QPHY-PCIE6-TX-RX
QualiPHY Enabled SATA Software Option	QPHY-SATA-TSG-RSG
QualiPHY Enabled SAS-3 Software Option	QPHY-SAS3
QualiPHY Enabled SFI Software Option	QPHY-SFI
QualiPHY Enabled USB 2.0 Software Option	QPHY-USB†
QualiPHY Enabled USB 3.2 Tx-Rx Software Option	QPHY-USB3.2-TX-RX
QualiPHY Enabled USB4 Transmitter and Receiver Compliance Software option	QPHY-USB4-TX-RX

* TF-ENET-B required. † TF-HDMI-3.3V-QUADPAK required. ‡ TF-USB-B required.
PCI Express, SuperSpeed USB (USB 3.0) and SATA Complete Hardware/Software
Test Solutions are available. Consult Factory.

ORDERING INFORMATION

Product Description

Product Code

Serial Data Test Fixtures

Test Fixture for 10GBase-T	TF-10GBASE-T
USB4 Sideband Test Coupon Fixture	TF-USB-C-SB
USB4 High-speed and Sideband Test Coupon Fixture	TF-USB-C-HS
Automotive Ethernet Breakout Test Fixture for 100Base-T1 and 1000Base-T1 Debug	TF-AUTO-ENET
Test Fixture HMTD-Connector (m) to SMA (f)	TF-AUTO-HMTD
Test Fixture MATEnet-Connector (m) to SMA (f)	TF-AUTO-MATENET
4 Pack of SMA Connector Boards for TF-AUTO-ENET	TF-AUTO-ENET-SMA
10/100/1000Base-T Ethernet Test Fixture	TF-ENET-B*
HDMI Pull-Up Terminator Quad Pack	TF-HDMI-3.3V-QUADPAK
SATA 1.5 Gb/s, 3.0 Gb/s and 6.0 Gb/s	TF-SATA-C-KIT
Compliance Test Fixture Measure Kit	
USB 2.0 Compliance Test Fixture	TF-USB-B
USB 3.0 and 3.1 Compliance Test Fixture	TF-USB3
Electrical Telecom Pulse Mask Test Package	WM8KHD-ET-PMT
MIPI M-PHY input offset adapter dual pack	TF-MIPI-MPHY-DUALPAK

*Includes ENET-2CAB-SMA018 and ENET-2ADA-BNCSMA

High-speed Serial Triggers and Decoders

80-bit NRZ, 8b/10b, and 64b/66b 8 Gbps Serial Trigger option for WaveMaster models	WM8KHD-8GBIT-SYMBOL-TD
80-bit NRZ, 8b/10b, and 64b/66b 16 Gbps Serial Trigger option for WaveMaster models	WM8KHD-16GBIT-SYMBOL-TD
80-bit NRZ, 8b/10b, and 64b/66b 16 Gbps Serial Trigger upgrade for SDA model	SDA8KHD-16GBIT-SYMBOL-TD

Serial Data Triggers and Decoders

100Base-T1 Trigger and Decode Option	WM8KHD-100Base-T1bus TD
100Base-T1 Trigger, Decode, Measure/Graph, and Eye Diagram Option	WM8KHD-100Base-T1bus TDME
10Base-T1S Trigger, Decode, Measure/Graph, and Eye Diagram Option	WM8KHD-10BASE-T1S TDME
10Base-T1S Trigger and Decode Option	WM8KHD-10BASE-T1S TD
MIL-STD-1553 Trigger and Decode Option	WM8KHD-1553 TD
MIL-STD-1553 Trigger, Decode, Measure/Graph, and Eye Diagram Option	WM8KHD-1553 TDME
64b/66b Decode Option	WM8KHD-64b66b D
8b/10b Decode Option	WM8KHD-8B10B D
ARINC 429 Bus Symbolic Decode, Measure/Graph, Eye Diagram Option	WM8KHD-ARINC429BUS DME SYMBOLIC
ARINC 429 Bus Symbolic Decode Option	WM8KHD-ARINC429bus DSymbolic
Trigger and Decode Option for I2S, LJ, RJ, and TDM	WM8KHD-AUDIOBUS TD
Trigger, Decode and Graph Option for I2S, LJ, RJ, and TDM	WM8KHD-AUDIOBUS TDG
CAN FD Trigger and Decode Option	WM8KHD-CAN FDbus TD
CAN/CAN FD Symbolic Trigger, Decode, Measure/Graph, and Eye Diagram Option	WM8KHD-CAN FDBUS TDME SYMBOLIC
CAN/CAN FD/CAN XL Trigger and Decode Option	WM8KHD-CAN XL TD
CAN Trigger and Decode Option	WM8KHD-CAN XL TDME SYMBOLIC
C-PHY (DSI-2/CSI-2) Decode Option	WM8KHD-CPHYBUS D
C-PHY (DSI-2/CSI-2) Decode, Measure/Graph and Physical Layer Test Option	WM8KHD-CPHYBUS DMP
DigRF 3G Decode Option	WM8KHD-DigRF3Gbus D
DigRF v4 Decode Option	WM8KHD-DigRFV4bus D
DisplayPort AUX Decode Option	WM8KHD-DPAUX D
DisplayPort AUX Decode, Measure/Graph, and Physical Layer Test Option	WM8KHD-DPAUX DMP
MIPI D-PHY Decode Option	WM8KHD-DPHYbus D
MIPI D-PHY Decode and Physical Layer Test Option	WM8KHD-DPHYbus DP
I ² C, SPI, UART-RS232 Trigger and Decode Bundle	WM8KHD-EMB TD
I ² C, SPI, UART-RS232 Trigger, Decode, Measure/Graph and Eye Diagram Bundle	WM8KHD-EMB TDME
Ethernet 10G Decode Option	WM8KHD-ENET10Gbus D
ENET Decode Option	WM8KHD-ENETbus D
Fibre Channel Decode Option	WM8KHD-FCbus D
FlexRay Trigger and Decode Option	WM8KHD-FlexRayBus TD
FlexRay Trigger, Decode, Measure/Graph and Physical Layer Option	WM8KHD-FLEXRAYBUS TDMP
I ² C Bus Trigger and Decode Option	WM8KHD-I2Cbus TD
I ² C Trigger, Decode, Measure/Graph, and Eye Diagram Option	WM8KHD-I2CBUS TDME
I ³ C Decode Option	WM8KHD-I3CBUS D
I ³ C Trigger and Decode Option	WM8KHD-I3CBUS TD
I ³ C Trigger, Decode, Measure/Graph and Eye Diagram Option	WM8KHD-I3CBUS TDME
I ³ C Decode, Measure/Graph, and Eye Diagram Option	WM8KHD-I3CBUS DME

Product Description

Product Code

Serial Data Triggers and Decoders (cont'd)

LIN Trigger and Decode Option	WM8KHD-LINbus TD
LIN Trigger, Decode, Measure/Graph and Eye Diagram Option	WM8KHD-LINBUS TDME
Manchester Decode Option	WM8KHD-Manchesterbus D
MDIO Decode	WM8KHD-MDIObus D
MIPI M-PHY Decode Option	WM8KHD-MPHYbus D
MIPI M-PHY Decode and Physical Layer Test Option	WM8KHD-MPHYbus DP
PCI Express Decode Option	WM8KHD-PCIEbus D
Decoder-Protocol Analyzer Synchronization Software Option	WM8KHD-ProtoSync
Decoder-Protocol Analyzer Synchronization with Bit Tracer Software Option	WM8KHD-ProtoSync-BT
PMBus Trigger, Decode, Measure/Graph, and Eye Diagram Option	WM8KHD-PMBUS TDME
SAS Decode Annotation Option	WM8KHD-SASbus D
SATA Decode Annotation Option	WM8KHD-SATAbus D
SENT Trigger and Decode Option	WM8KHD-SENTbus TD
SENT Trigger, Decode, Measure/Graph, and Eye Diagram Option	WM8KHD-SENTbus TDME
SMBUS Trigger and Decode Option	WM8KHD-SMBUS TD
SMBUS Trigger, Decode, Measure/Graph, and Eye Diagram Option	WM8KHD-SMBUS TDME
SpaceWire Decode Option	WM8KHD-SpaceWirebus TD
SPI Trigger and Decode Option	WM8KHD-SPIbus TD
SPI Trigger, Decode, Measure/Graph, and Eye Diagram Option	WM8KHD-SPIBUS TDME
SPMI Trigger and Decode Option	WM8KHD-SPMibus TD
SPMI Trigger, Decode, Measure/Graph, and Eye Diagram Option	WM8KHD-SPMibus TDME
SPMI Decode Option	WM8KHD-SPMIBUS D
UART and RS-232 Trigger and Decode Option	WM8KHD-UART-RS232bus TD
UART-RS232 Trigger, Decode, Measure/Graph and Eye Diagram Option	WM8KHD-UART-RS232BUS TDME
MIPI UniPro Protocol Decoder	WM8KHD-UNIPRObus D
USB-PD Trigger and Decode Option	WM8KHD-USBPD TD
USB-PD Trigger, Decode, Measure/Graph and Physical Layer Test Option	WM8KHD-USBPD TDMP
USB2-HSIC Decode Option	WM8KHD-USB2-HSICbus D
USB4-SB Trigger and Decode Option	WM8KHD-USB4SB TD
USB4 Decode, Measure/Graph, and Eye Measurements Option	WM8KHD-USB4BUS DME
USB4-SB Trigger, Decode, Measure/Graph, and PHY Meas. Option	WM8KHD-USB4SB TDMP
USB 2.0 Trigger and Decode Option	WM8KHD-USB2bus TD
USB 2.0 Decode Option	WM8KHD-USB2BUS D
USB 2.0 Decode, Measure/Graph, and Eye Diagram Option	WM8KHD-USB2BUS DME
USB 3.2 Decode Option	WM8KHD-USB32BUS D

Remote Control/Network Options

USB to GPIB adapter for GPIB Device Ability	USB2-GPIB
USB to GPIB adapter for GPIB Host Ability	GPIB-HOST

General Purpose and Application Specific Software Options

Spectrum Analyzer Option (1 trace)	WM8KHD-SPECTRUM-1
Spectrum Analyzer Option (2 traces + reference trace)	WM8KHD-SPECTRUM-PRO-2
MAUI Studio Pro Software	MAUI STUDIO PRO
Digital Filter Software Package	WM8KHD-DFP2
EMC Pulse Parameter Software Package	WM8KHD-EMC
Power Analysis Option	WM8KHD-PWR
Digital Power Management Analysis Option	WM8KHD-DIG-PWR-MGMT
Clock Jitter Analysis with Four Views Software Package	WM8KHD-JITKIT

General Accessories

ProLink to 2.92mm Adapter with Probe Power and Communication Pass Through	LPA-2.92
ProLink to K/2.92 mm Adapter	LPA-K-A
ProLink to 2.92mm ProAxial Adapter Kit	LPA-2.92-PX-KIT

ORDERING INFORMATION

Product Description

Product Code

Probes and Probe Accessories

30 GHz differential probe with ProAxial interface	DH30-PX
25 GHz differential probe with ProAxial interface	DH25-PX
20 GHz differential probe with ProLink interface	DH20-PL
High Voltage Fiber Optic Probe, 150 MHz Bandwidth	HVFO108
Power/Voltage Rail Probe. 2 GHz bandwidth, 1.2x attenuation, +/-60V offset, +/-800mV	RP2060
Power/Voltage Rail Probe. 4 GHz bandwidth, 1.2x attenuation, +/-60V offset, +/-800mV	RP4060
500 MHz 60 V Common Mode Differential Probe	DL05-HCM
1 GHz 60 V Common Mode Differential Probe	DL10-HCM
1.0 GHz, 0.9 pF, 1 M Ω High Impedance Active Probe	ZS1000
1.5 GHz, 0.9 pF, 1 M Ω High Impedance Active Probe	ZS1500
2.5 GHz, 0.9 pF, 1 M Ω High Impedance Active Probe	ZS2500
4.0 GHz, 0.6 pF, 1 M Ω High Impedance Active Probe	ZS4000
400 MHz, 1kV Vrms High-Voltage Passive Probe	HVP120
6kV High Voltage Passive Probe, 500 MHz	PPE6KV-A
25 MHz High Voltage Differential Probe	HVD3102A
1 kV, 25 MHz High Voltage Differential Probe (without tip accessories)	HVD3102A-NOACC
120 MHz High Voltage Differential Probe	HVD3106A
1 kV, 120 MHz High Voltage Differential Probe (without tip accessories)	HVD3106A-NOACC
80 MHz, High Voltage Differential Probe with 6 m Cable	HVD3106A-6M
2 kV, 120 MHz High Voltage Differential Probe	HVD3206A
2 kV, 80 MHz High Voltage Differential Probe with 6 m Cable	HVD3206A-6M
2 kV, 400 MHz High Voltage Differential Probe	HVD3220
6 kV, 100 MHz High Voltage Differential Probe	HVD3605A
700 V, 25 MHz High-Voltage Differential Probe	AP031
500 MHz Differential Probe	AP033
500 MHz, 1.0 pF Active Differential Probe, \pm 8 V	ZD500
1 GHz, 1.0 pF Active Differential Probe, \pm 8 V	ZD1000
1.5 GHz, 1.0 pF Active Differential Probe, \pm 8 V	ZD1500
4 GHz ProBus2 Differential Probe w/ Dx10-SI, Dx10-QC, Dx10-SP	D410-A-PB2
4 GHz ProBus2 Differential Probe w/ Dx20-SI, Dx20-QC, Dx20-SP	D420-A-PB2
6 GHz ProBus2 Differential Probe w/ Dx10-SI, Dx10-QC, Dx10-SP	D610-A-PL
6 GHz ProBus2 Differential Probe w/ Dx20-SI, Dx20-QC, Dx20-SP	D620-A-PL
4 GHz ProBus2 Differential Probe with Adjustable Tip	D400A-AT-PB2
6 GHz ProLink Differential Probe with Adjustable Tip	D600A-AT-PL
Programmable Current Sensor to ProBus Adapter (for use with third party current sensors)	CA10
30 A, 50 MHz Current Probe - AC/DC, 30 A rms, 50 A Peak Pulse, 1.5 meter cable	CP030
30 A, 10 MHz Current Probe - AC/DC, 30 A rms, 50 A Peak Pulse, 3 meter cable	CP030-3M
30 A, 50 MHz High Sensitivity Current Probe - AC/DC, 30 A rms, 50 A Peak Pulse, 1.5 meter cable	CP030A
30A, 100 MHz Current Probe - AC/DC, 30 A rms, 50 A Peak Pulse, 1.5 meter cable	CP031
30 A, 100 MHz High Sensitivity Current Probe - AC/DC, 30 A rms, 50 A Peak Pulse, 1.5 meter cable	CP031A
150 A, 10 MHz Current Probe - AC/DC, 150 A rms, 500 A Peak Pulse, 2 meter cable	CP150
150 A, 5 MHz Current Probe - AC/DC, 150 A rms, 500 A Peak Pulse, 6 meter cable	CP150-6M
500 A, 2 MHz Current Probe - AC/DC, 500 A rms, 700 A Peak Pulse, 6 meter cable	CP500
7.5 GHz Low Capacitance Passive Probe (\pm 10, 1 k Ω ; \pm 20, 500 Ω)	PP066
500 MHz Passive Probe, 2.5mm	PP021-1
500 MHz Passive Probe, 5mm	PP025-1
TekProbe to ProBus Probe Adapter	TPA10

A variety of other active voltage and current probes are also available. Consult Teledyne LeCroy for more information.



Customer Service

Teledyne LeCroy oscilloscopes and probes are designed, built and tested to ensure high reliability. In the unlikely event you experience difficulties, our digital oscilloscopes are fully warranted for three years and our probes are warranted for one year. This warranty includes:

- No charge for return shipping
- Long-term 7-year support
- Upgrade to latest software at no charge



1-800-5-LeCroy
teledynelecroy.com

Local sales offices are located throughout the world.
Visit our website to find the most convenient location.

© 2023 by Teledyne LeCroy, Inc. All rights reserved. Specifications, prices, availability, and delivery subject to change without notice.

PCI Express® is a registered trademark and/or service mark of PCI-SIG. USB4® and USB Type-C® are registered trademarks and/or service marks of USB-IF. MATLAB® is a registered trademark of The MathWorks, Inc. All other product or brand names are trademarks or requested trademarks of their respective holders.

wavemaster8000hd-ds-05sep23